

iLUXUS WELCOME

INTELLIGENT LUXURY BUILDING SOLUTIONS

www.i-luxus.de



ABOUT i-luxus

i-luxus provide with its unique and exclusive character are the practically endless possibilities regarding functionality, finish, recessed or surface-mounted installation, combination options and customizations.



i-luxus is a high-grade supplier of Switch&Socket collection and modern sustainable KNX building Technology. We aim to innovate and help the the world's energy challenges. Our solutions make homes, offices, factories more energy efficient and safer, and energy more affordable.

PRODUCT PHILOSOPHY

We Have started and tried our journey with a new energy and a new hope, make a difference in yhe current market, in which technologyi efficiency and design can be mentioned in a repeatin pattern. Many long forgotten names and concepts have been revived and mixed to commemorate the millenial history. That have shaped our present. The names and characteristic have been so is used as widely as possible. With the desire not to be to forgotten...

BEYOND THE TIME



WHAT WE OFFER

Conventional System

i-luxus offers the most suitable solutions in terms of aesthetics, color and form with products belonging to conventional switch socket systems for architectural projects

KNX Intelligent Buildings

Necessary solutions for smart building systems are included in the product range.

A close-up photograph of a black, brushed metal button with a circular, reflective center, mounted on a dark surface. The background shows a modern interior with a white wire chair and a vase of white flowers.

ATHENE
Brushed Black
Leon Button

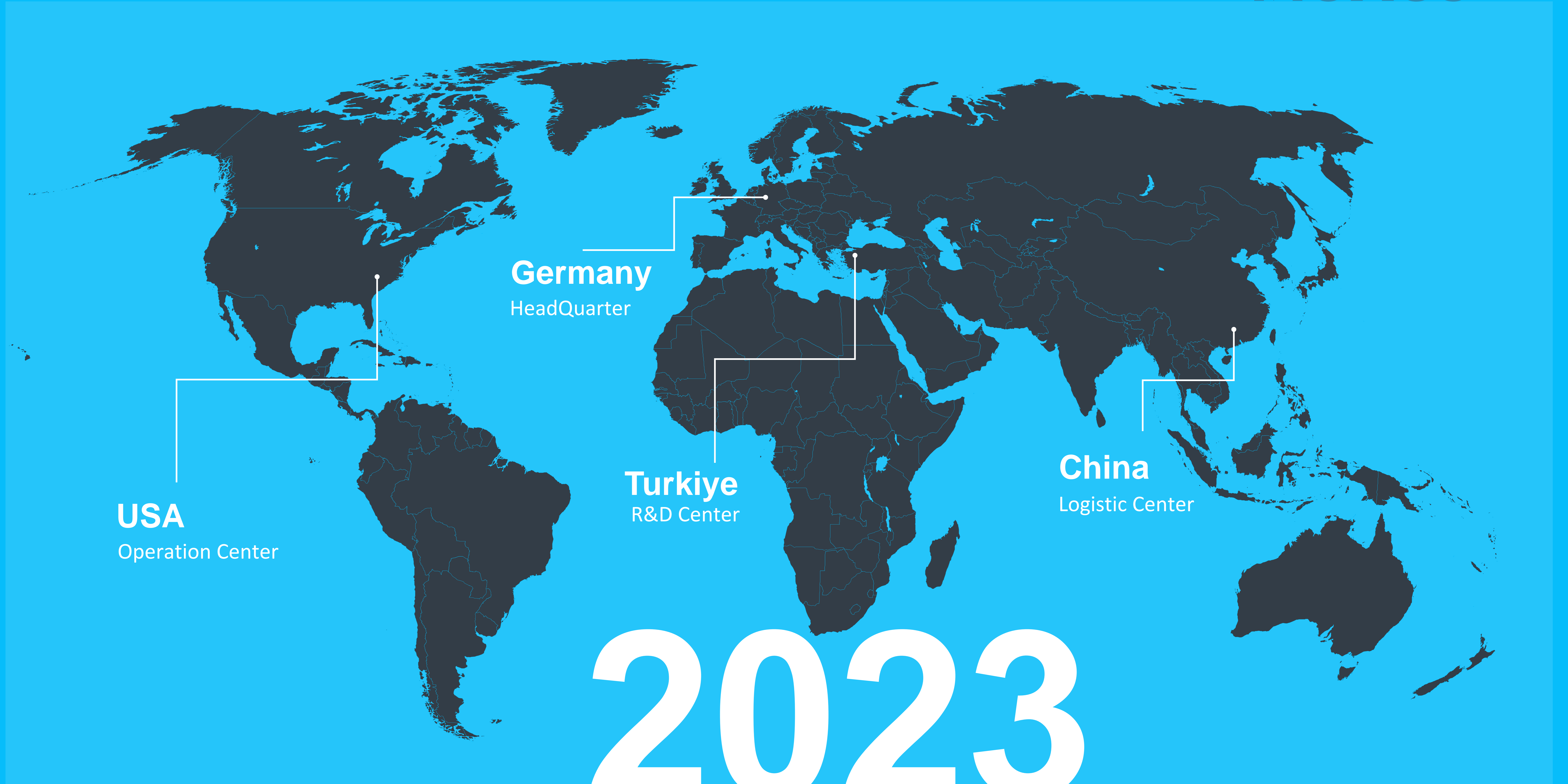

USA
Operation Center

Germany
HeadQuarter

Turkiye
R&D Center

China
Logistic Center

2023



MODERN PORTFOLIO

We offer and produce; product solutions for all different types of projects. Due to the advantage of being an R&D oriented brand, we provide hardware and software support for project development.

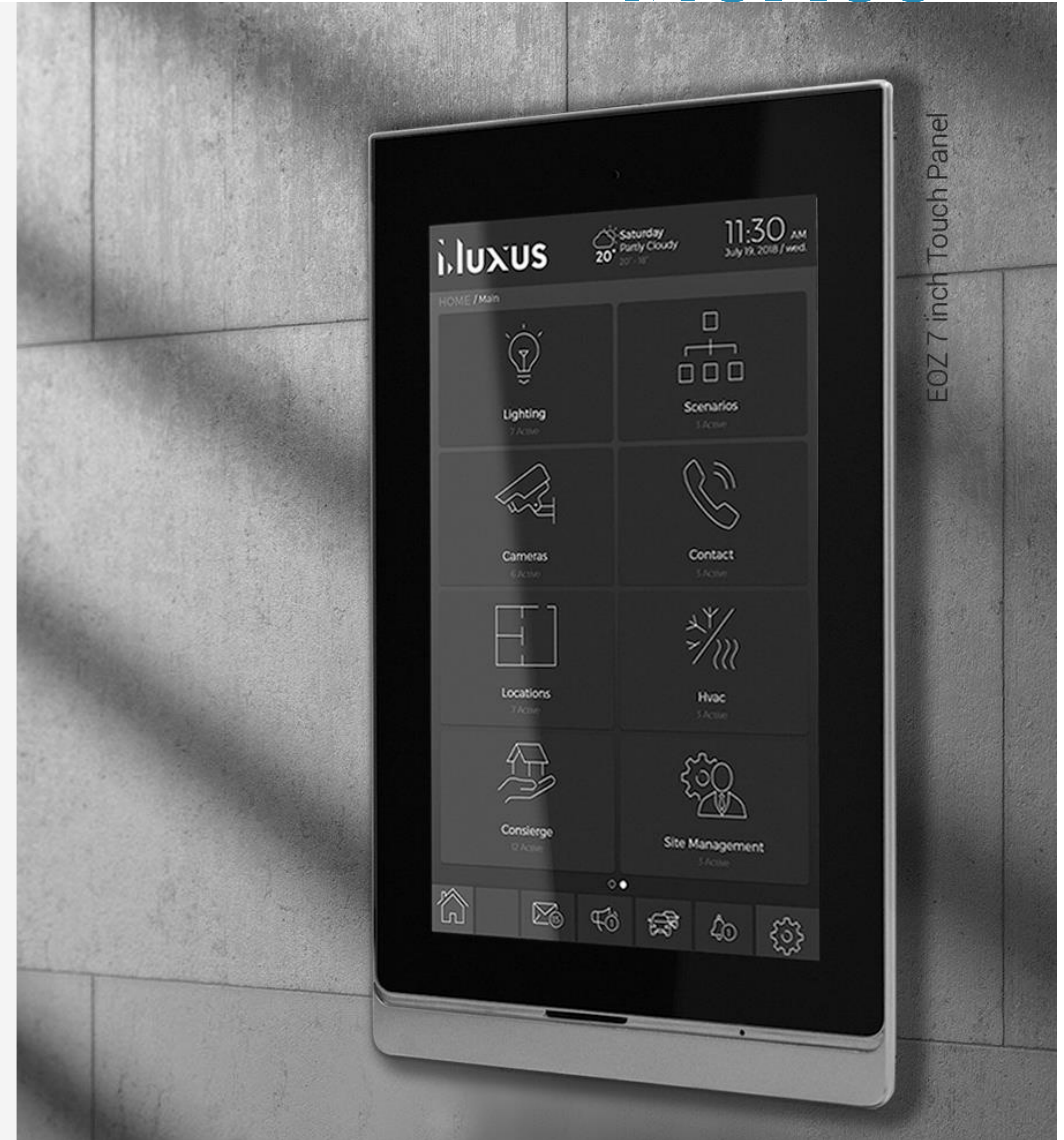

CREATIVE DESIGN

As i-luxus, we produce creative designs that will make life easier. Thanks to these designs, we bring together classic and modern designs in the same environment.

BEYOND THE TIME



PRODUCT SHOWCASE

In order to offer the necessary product variety required by smart building systems; Touch Panel, panel equipment and smart switches required for control, classical switch sockets and thermostatic control units are included in the product range.

PRODUCT RANGE



ATHENE

Athens offers special solutions for horizontal and vertical architecture with its **boutique design** and craftsmanship concept.

Switch&Sockets

BRASS & HANDMADE

i-luxus



PLATE ALTERNATIVES



Krepis



Radius

BUTTON ALTERNATIVES

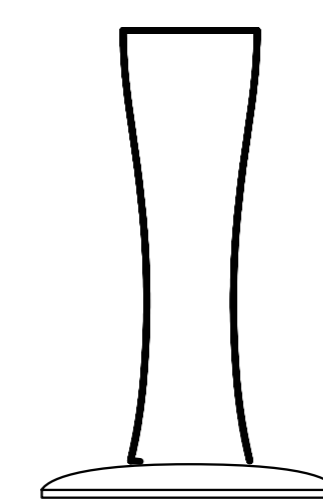

Hera

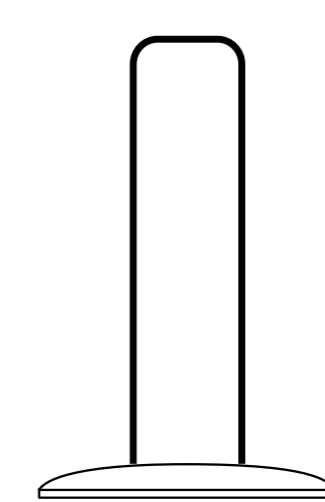

Peristyl

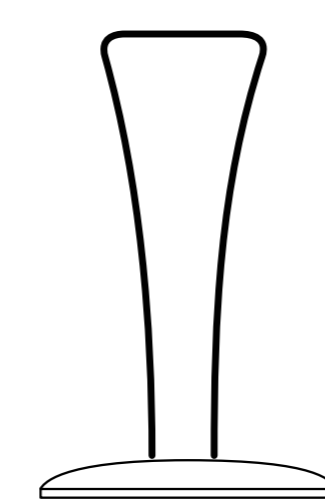

Cella

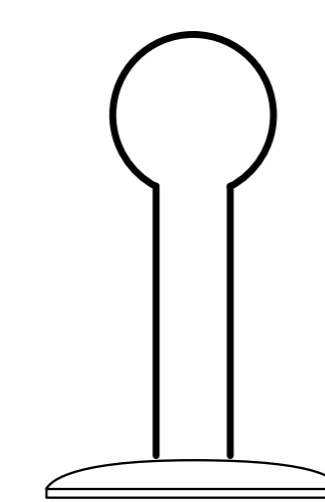

Odeon

COLOR ALTERNATIVES



AC Antique Copper AB Antique Bronze BR Bronze BC Brushed Copper
 MC Matt Copper MG Matt Gold BG Brushed Gold BS Brushed Steel
 BB Brushed Black BW Brown PB Parliament Blue

DR Dore AN Anthracite WH White
 BL Blue RD Red OR Orange GR Green

ATHENE

PRODUCT DETAILS

i-luxus offers solutions suitable for every space project with its completely hand-made and eniquely designed products. By combining technology with handcraft; brings together aesthetics, comfort and luxury. In addition to the conventional switch-socket series.

Athene

FRAME ALTERNATIVES

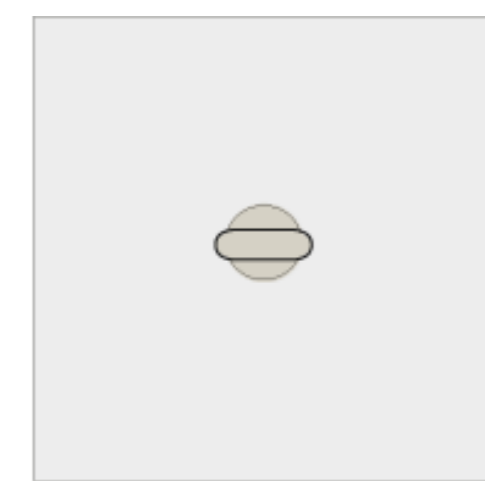

1 Gang : 85x85 mm

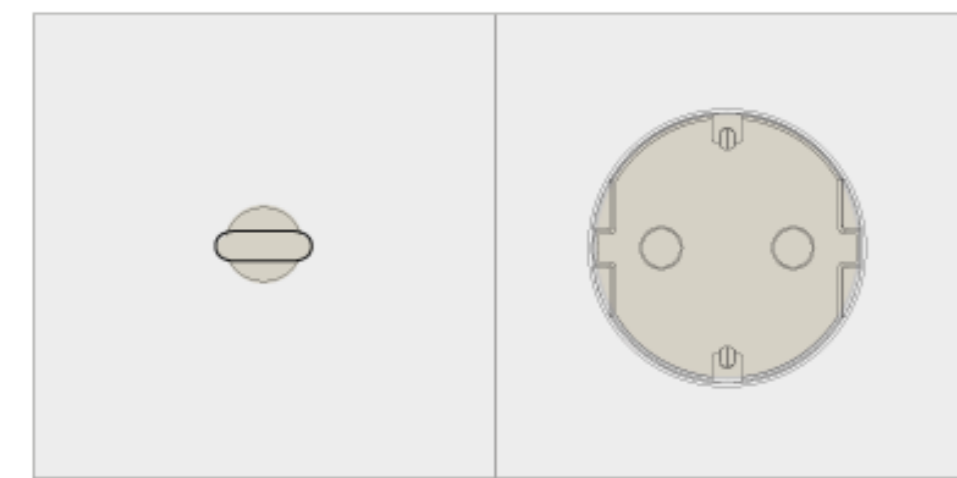

2 Gang : 85x155,5 mm

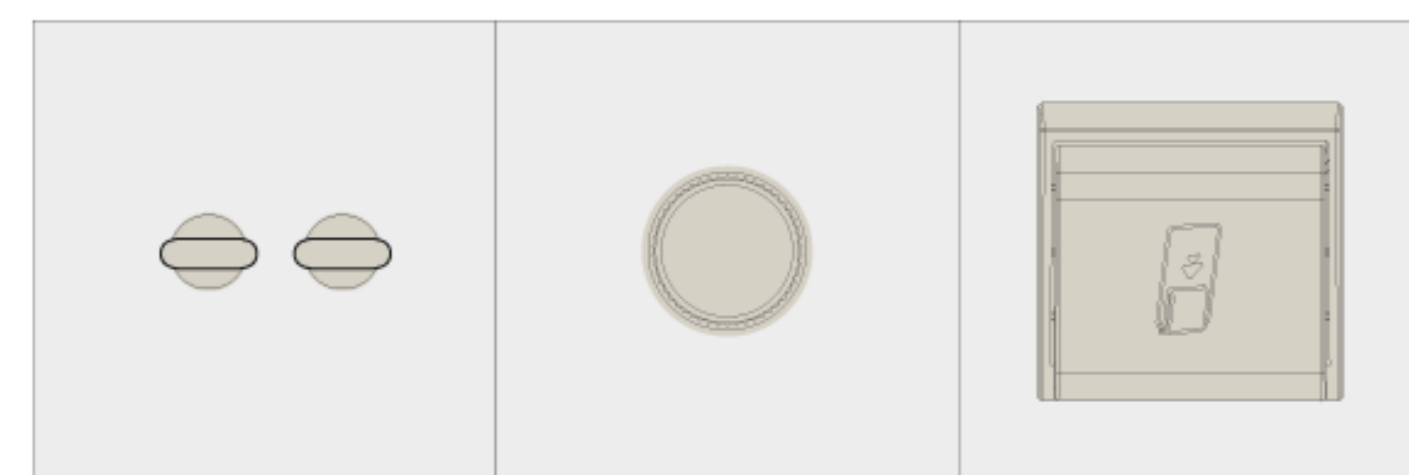

3 Gang : 85x226 mm

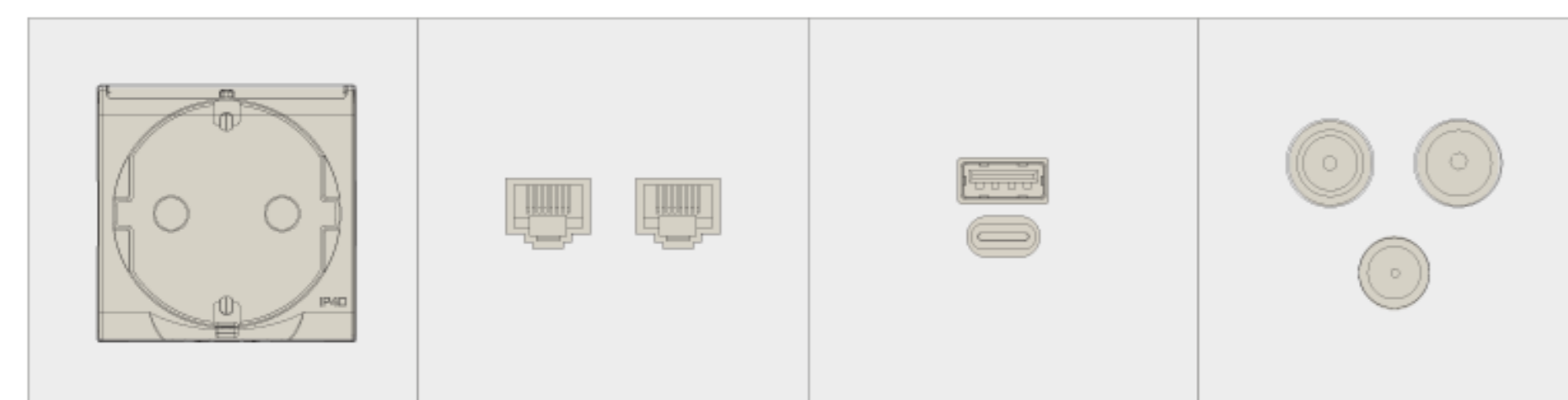

4 Gang : 85x298 mm

* 5 Gang Frame option dimensions : 85x370 mm
All frames has 4 mm thickness

PRODUCT DETAILS

Athene series offers aesthetic solutions by providing maximum product use in minimum space with different frame options.

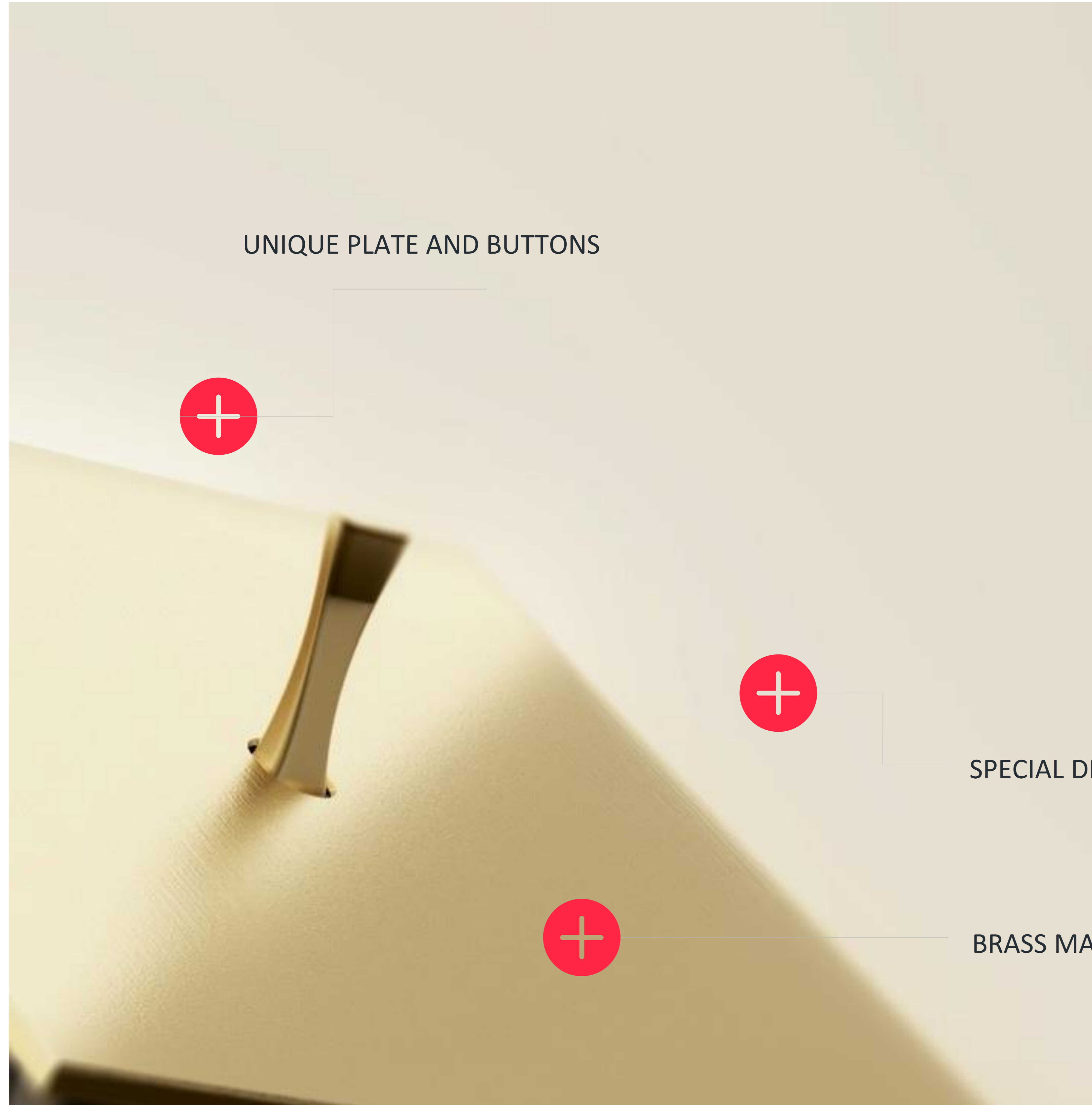

UNIQUE PLATE AND BUTTONS

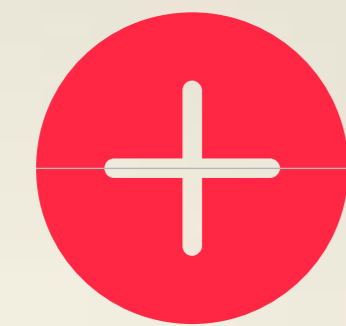

SPECIAL DESIGN FOR PROJETS



BRASS MATERIAL

PRODUCT BENEFITS

Thanks to the variety of frames and buttons with angular and oval lines for decoration needs in different concepts, it also allows you to make project-specific designs in addition to fully compatible designs.

AthenB4

NEW DESIGN

Thanks to its modern new design features, Athene B4 offers classic key and smart key solutions for smart building systems at the same time with its KNX infrastructure.

RADIUS

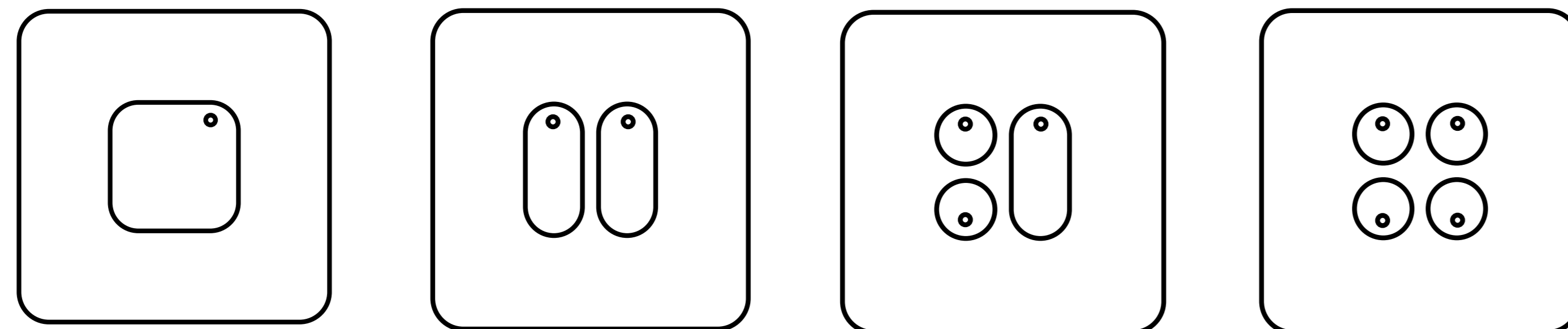

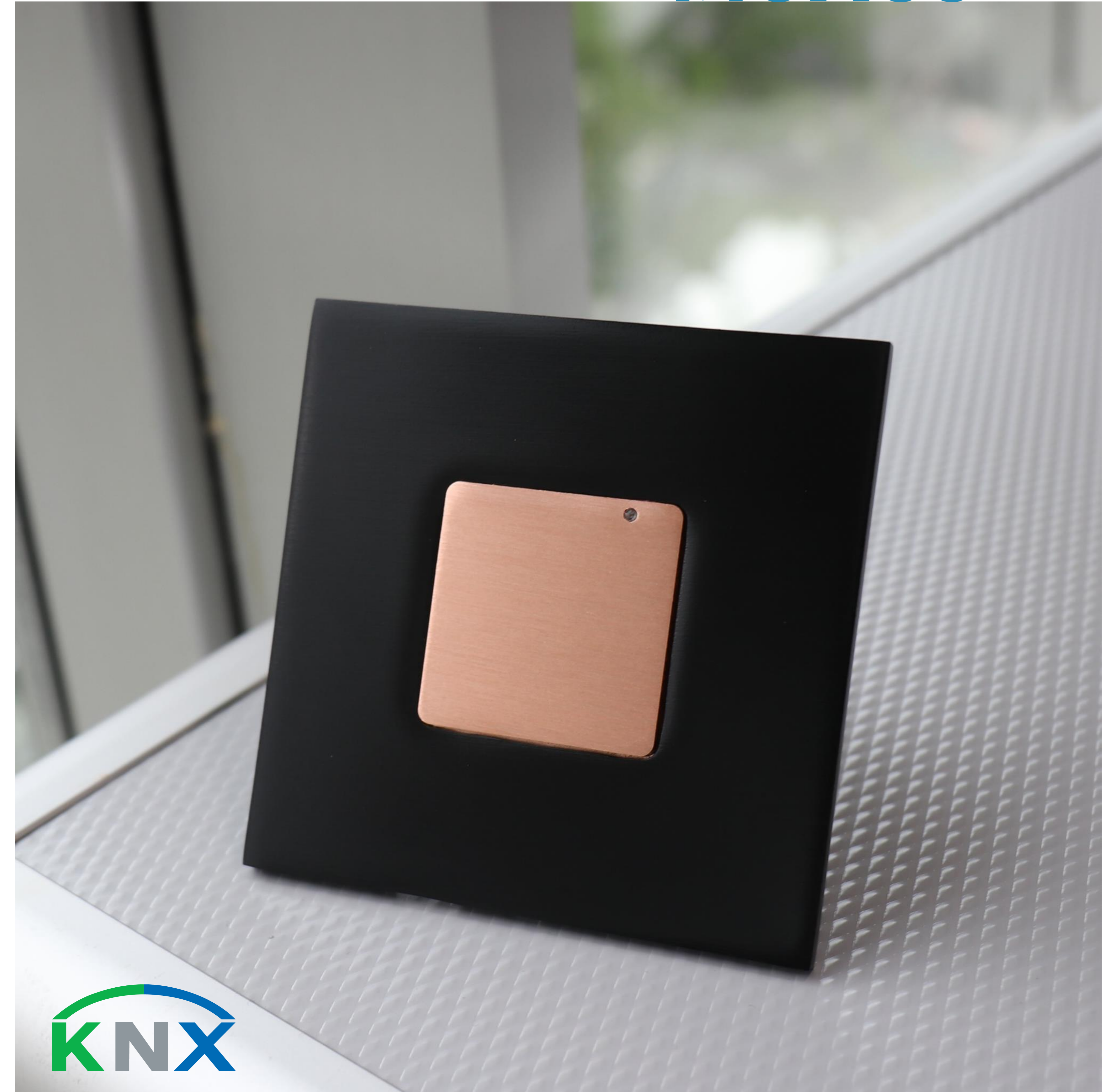
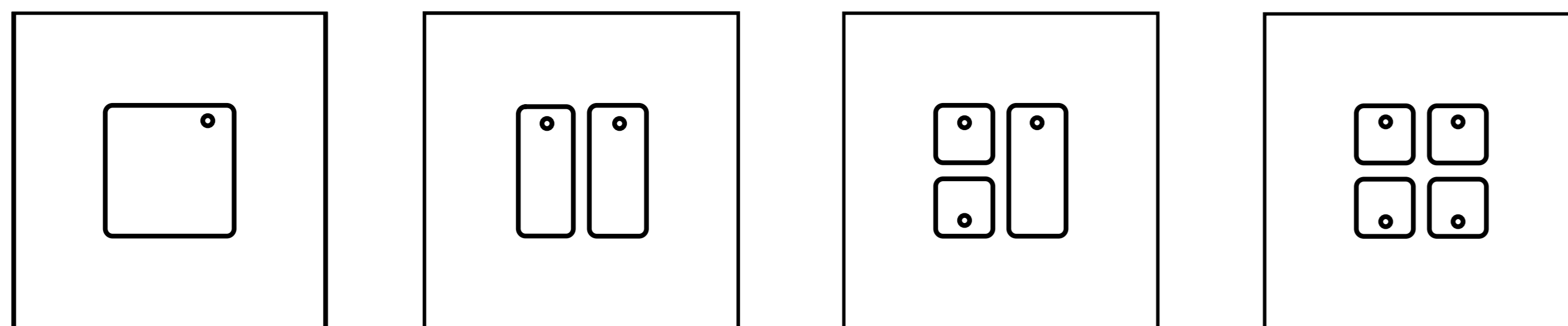

KREPIS

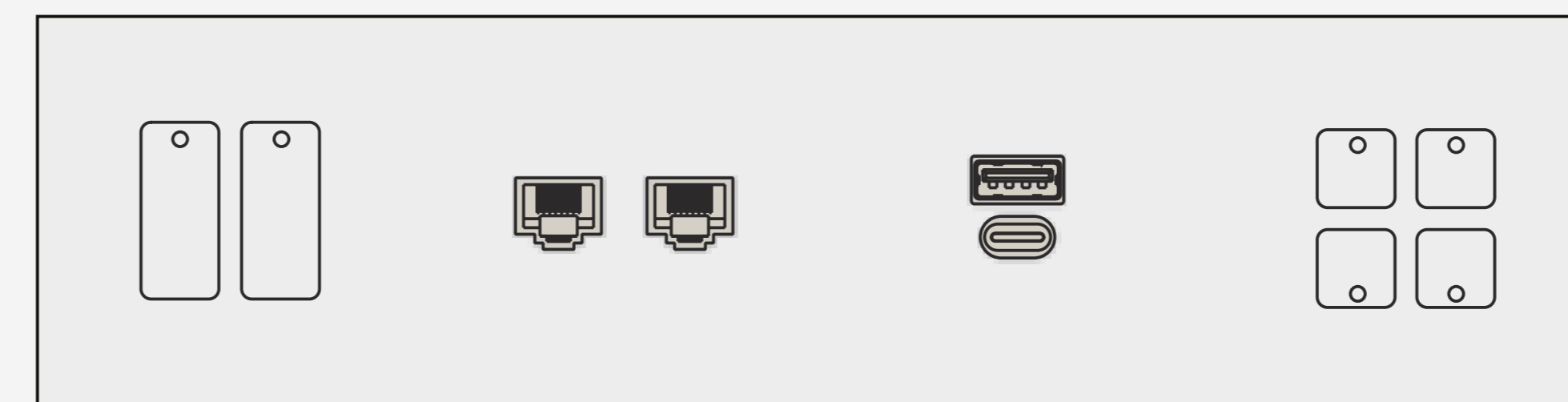
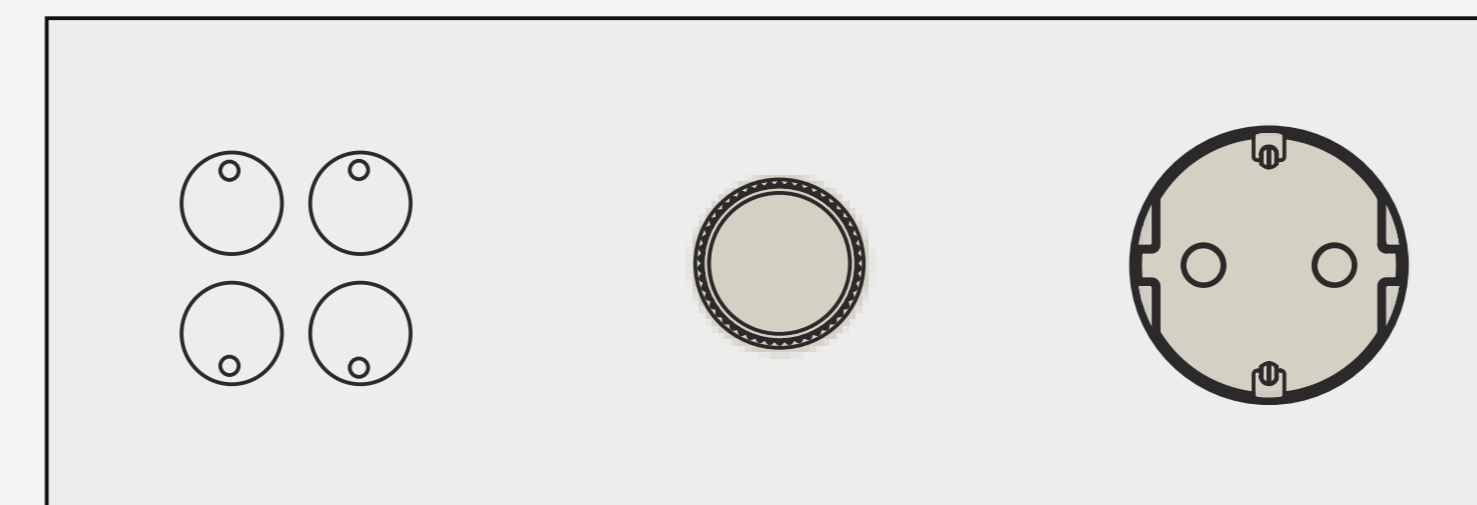
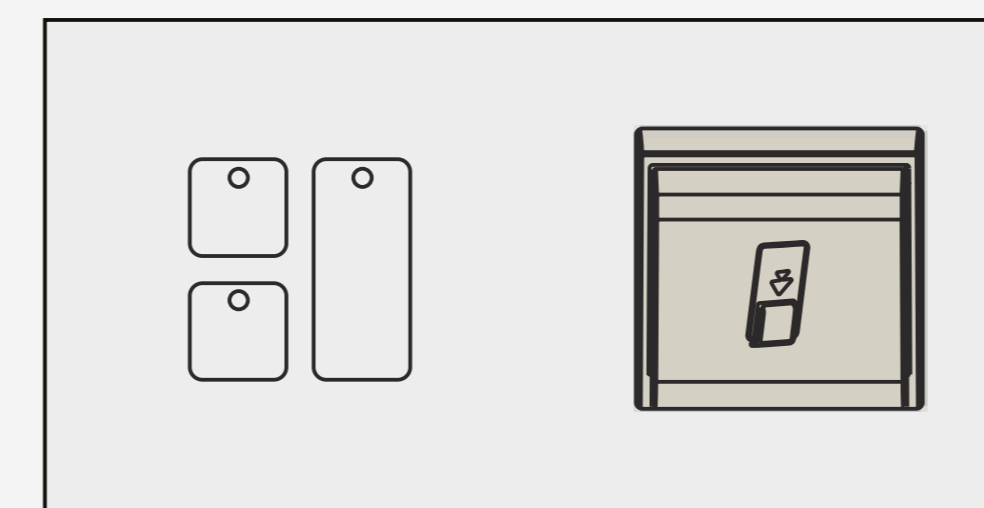

PERFECT COMBINATIONS

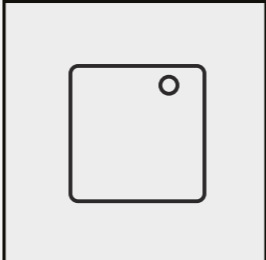
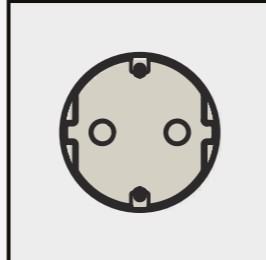
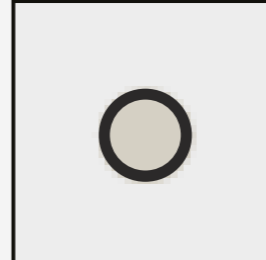
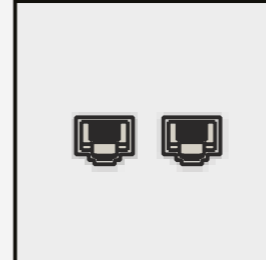
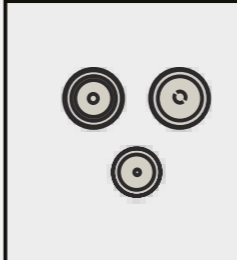
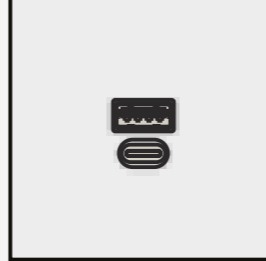
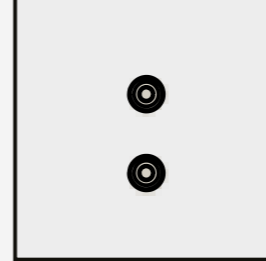
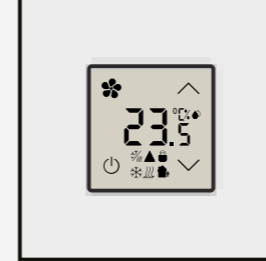
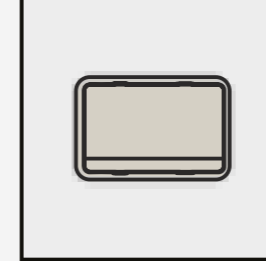

1 Gang : 85x85 mm 2 Gang : 85x155,5 mm 3 Gang : 85x226 mm 4 Gang : 85x298 mm 5 Gang : 85x370 mm

- | | | | | |
|---|--|---|---|--|
| 
Switches | 
Sockets | 
Dimmer | 
RJ11/45 | 
TV/SAT |
| 
HDMI/USB | 
Audio/Video | 
Thermostat | 
Indicators | 
EnergySaver |



NEW B4 SQUARE



EPHESUS

An aesthetic solution for air conditioning.

Very thin zamac material, High quality product with push buttons, touch screen with room temperature & humidity sensor. And ambient sensor.

RoomController & PushButtons

HANDMADE

i.luxus



EPHESUS DESIGNS

- Temperature & Humadity & Ambient Sensors
- Thin frame
- 2 / 3 / 4 / 5 / 6 Gang buttons



3 Gang Push Buttons



2 Gang Room Controller



4 Gang Room Controller

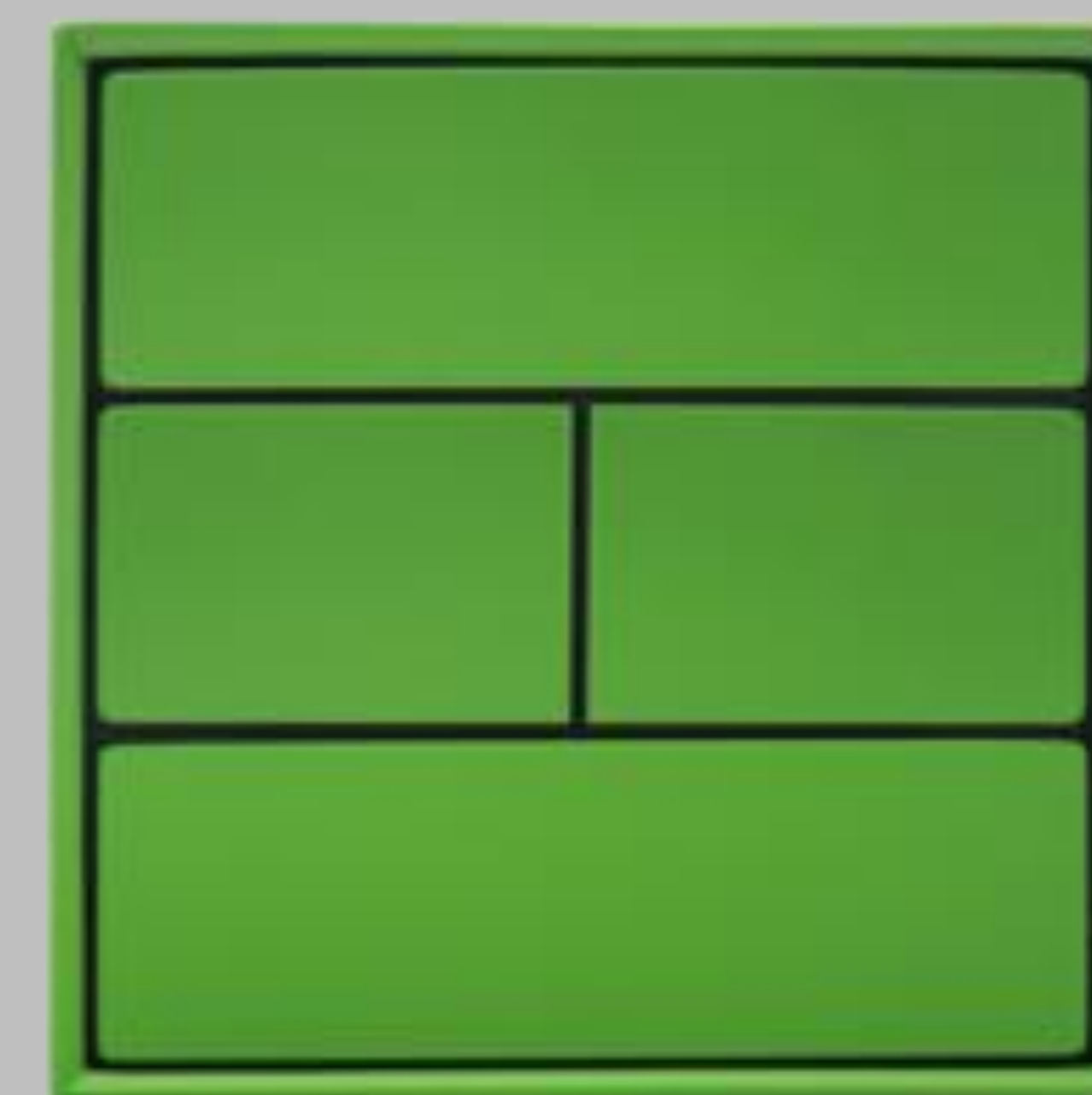

4 Gang Push Buttons



5 Gang Push Buttons



6 Gang Push Buttons

EPHESUS RoomController

Ephesus KNX Room Controller have a stylish and pure design . The dyeing process is done with its unique craftsmanship. Our devices which are produced in two models with two and four buttons, can be easily mounted to the universal round or square plaster cases. At first sight, it is perceived as a KNX based room controller. The Ephesus KNX room Controller features a simple and friendly interface design with temperature, humidity and ambient light sensors.

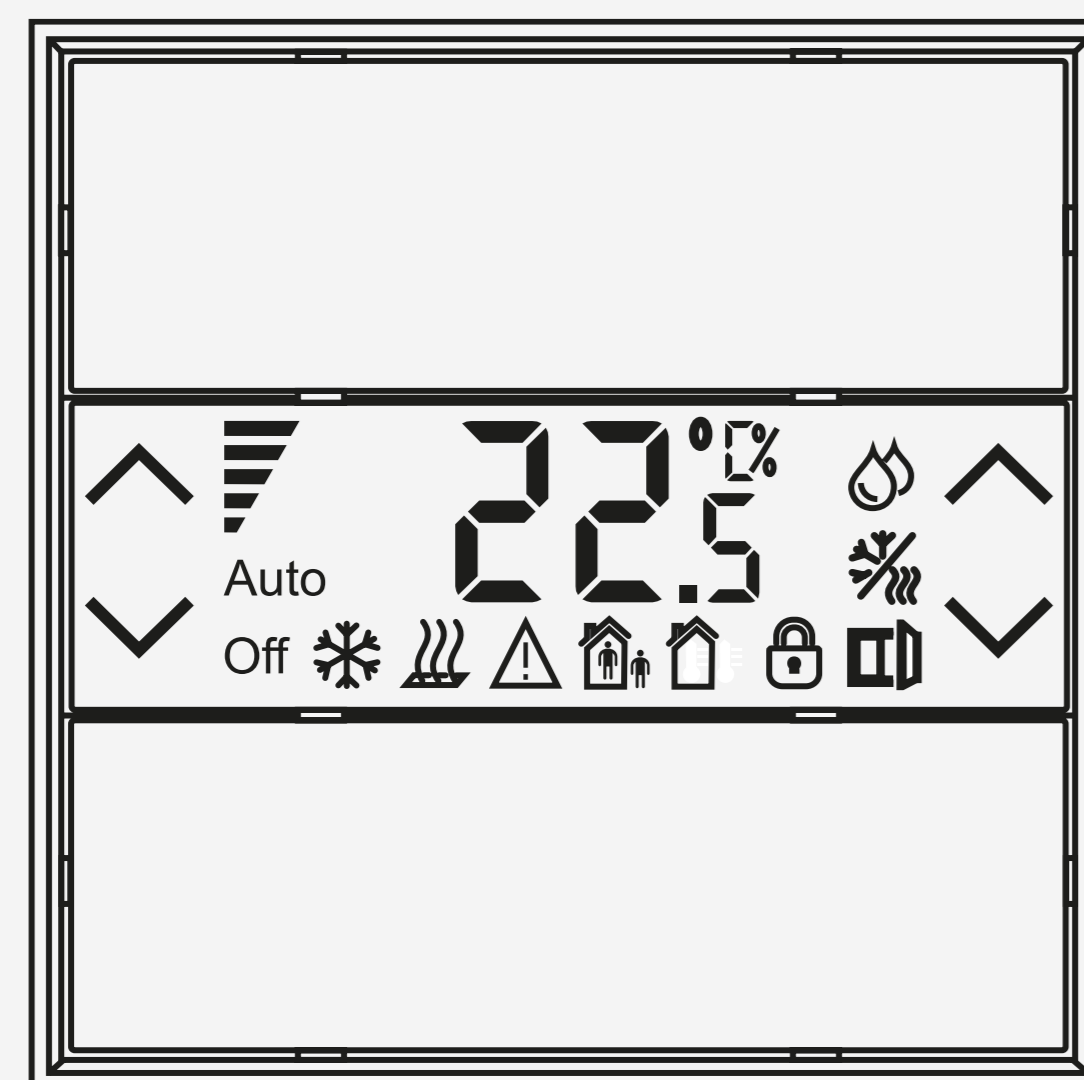

2 Gang 4 Button

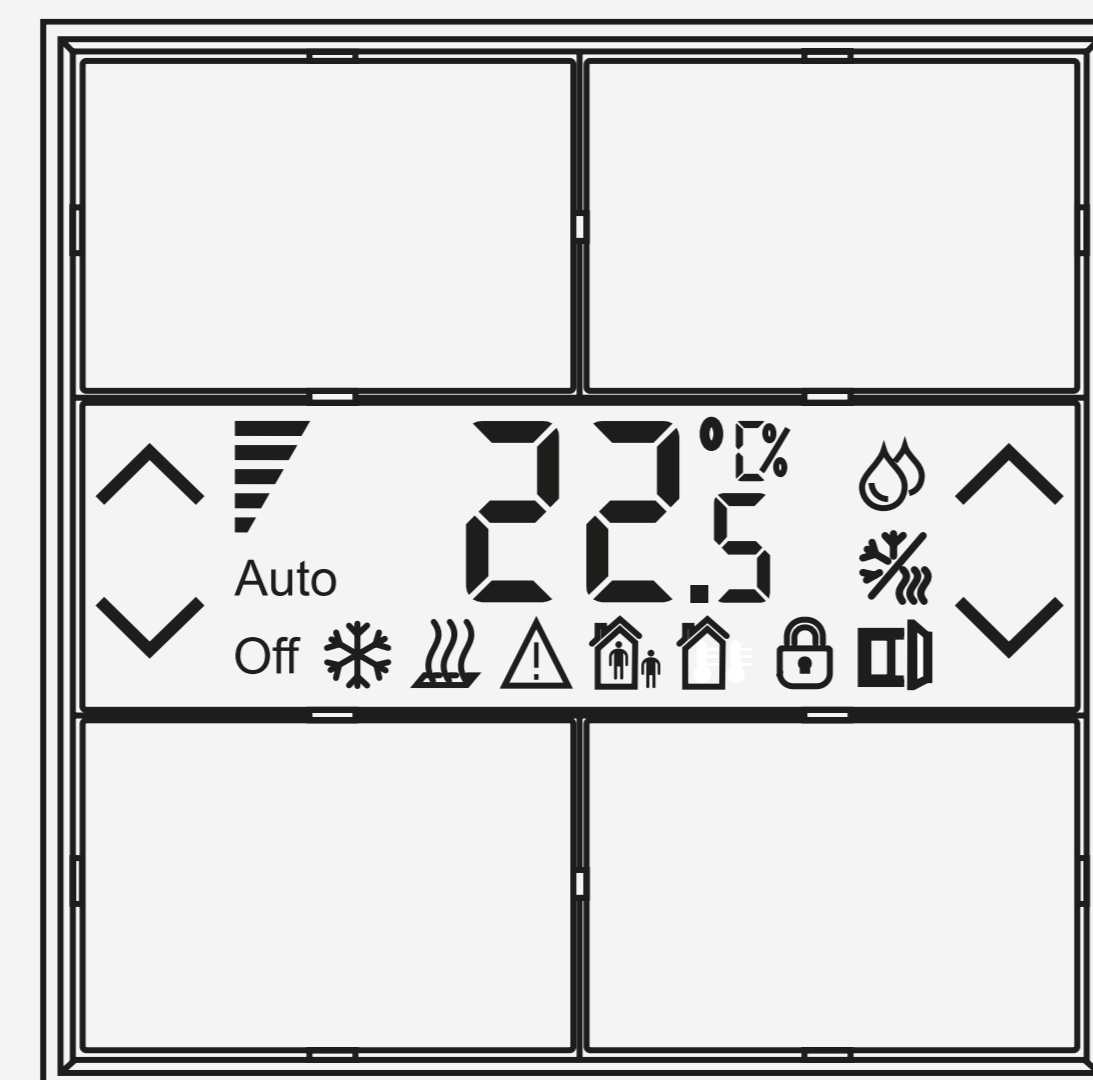

4 Gang 8 Button



EPHESUS PushButton

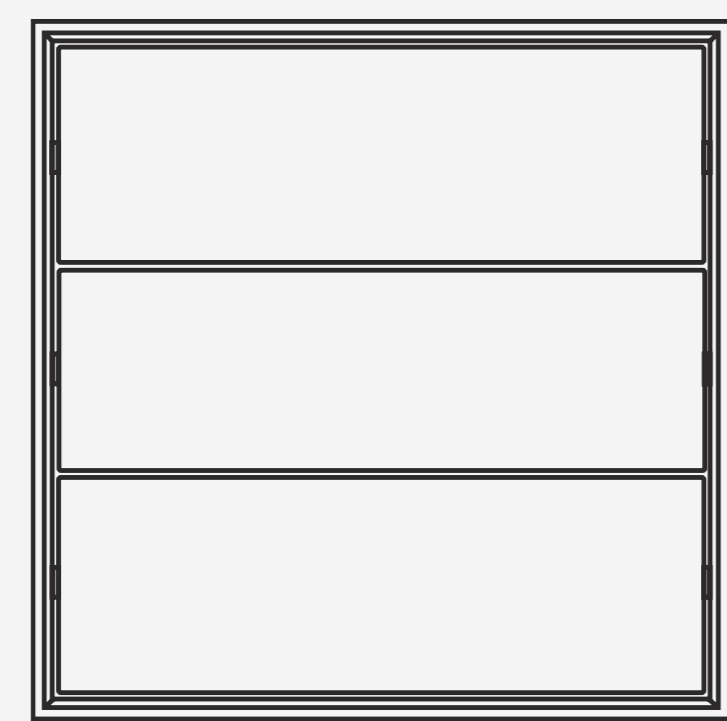

3 Gang 6 Button.

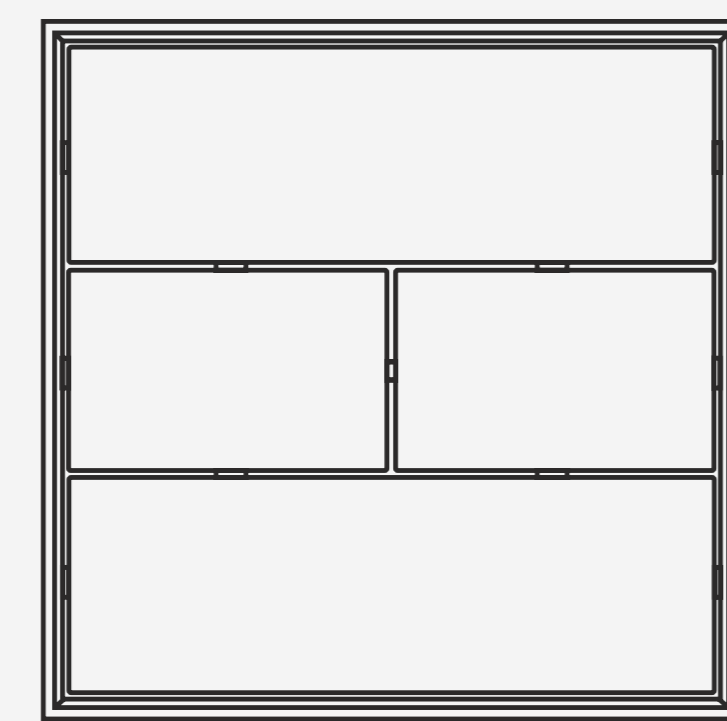

4 Gang 8 Button.

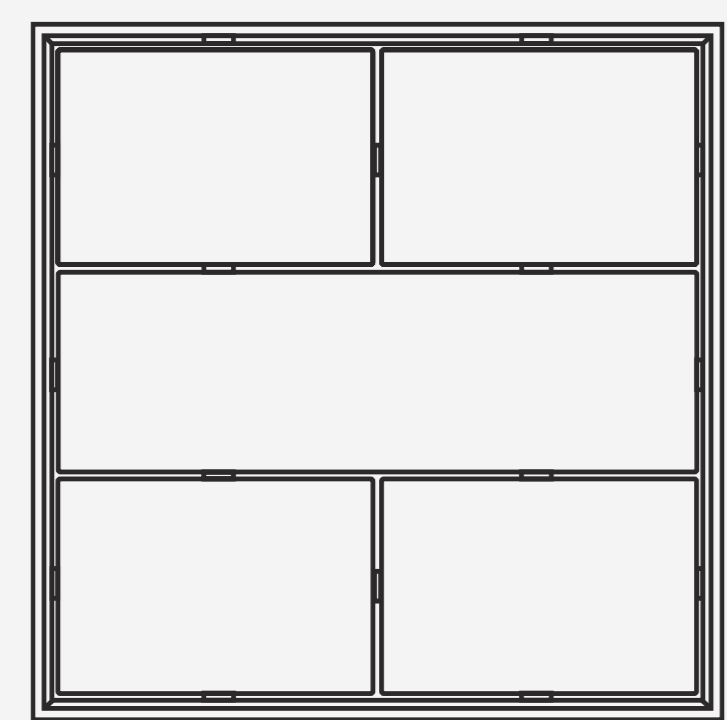

5 Gang 10 Button.

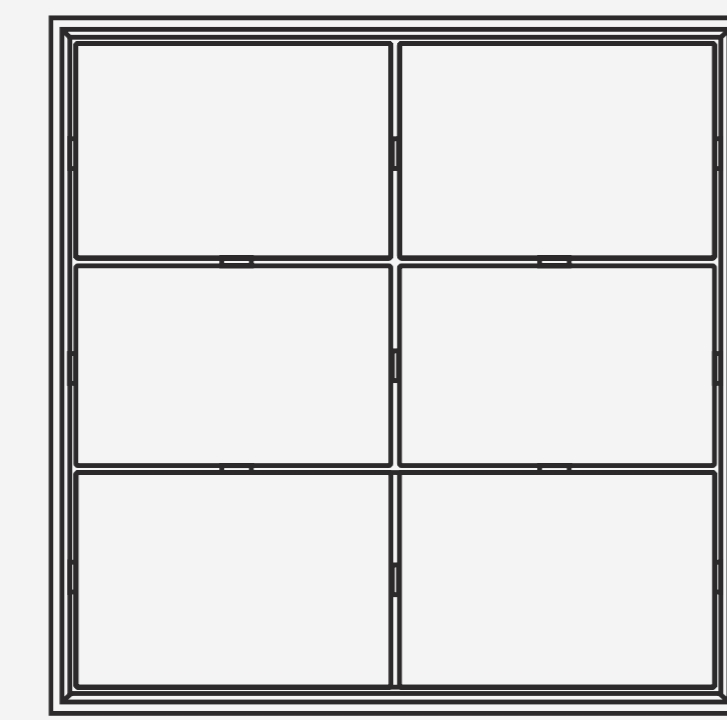

6 Gang 12 Button.



EOZ TouchPanel

i-luxus products and systems, offering up-to-date technologies and the most common smart building solutions; While providing the desired functionality and flexibility thanks to its customizable structures, it also offers the last possible comfort privileges.



10.1 Inch

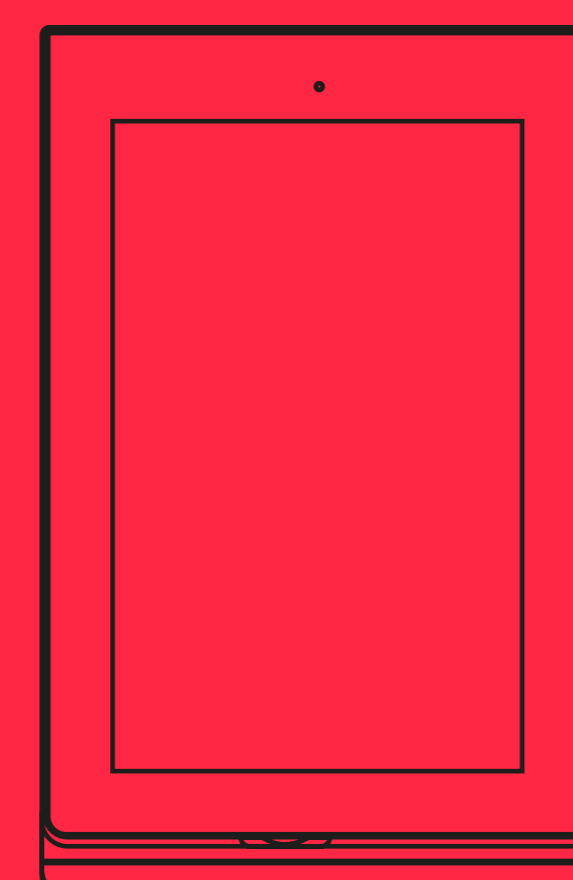

7 Inch



EOZAPP

- **KNX** New Chipset Technology
- External 6 Channel **Infrared Module** (32 -40 KHz)
- **External 3 and 6 Output** modules with 5A Output Current
- Standart **6 Inputs** (5V)
- IOS & Android mobile application control
- 3 different mobile integration way
- **Dynamic UI application** same with mobile
- Wifi, Cloud, Port forwarding



7" & 10.1" size options
Mobil Application



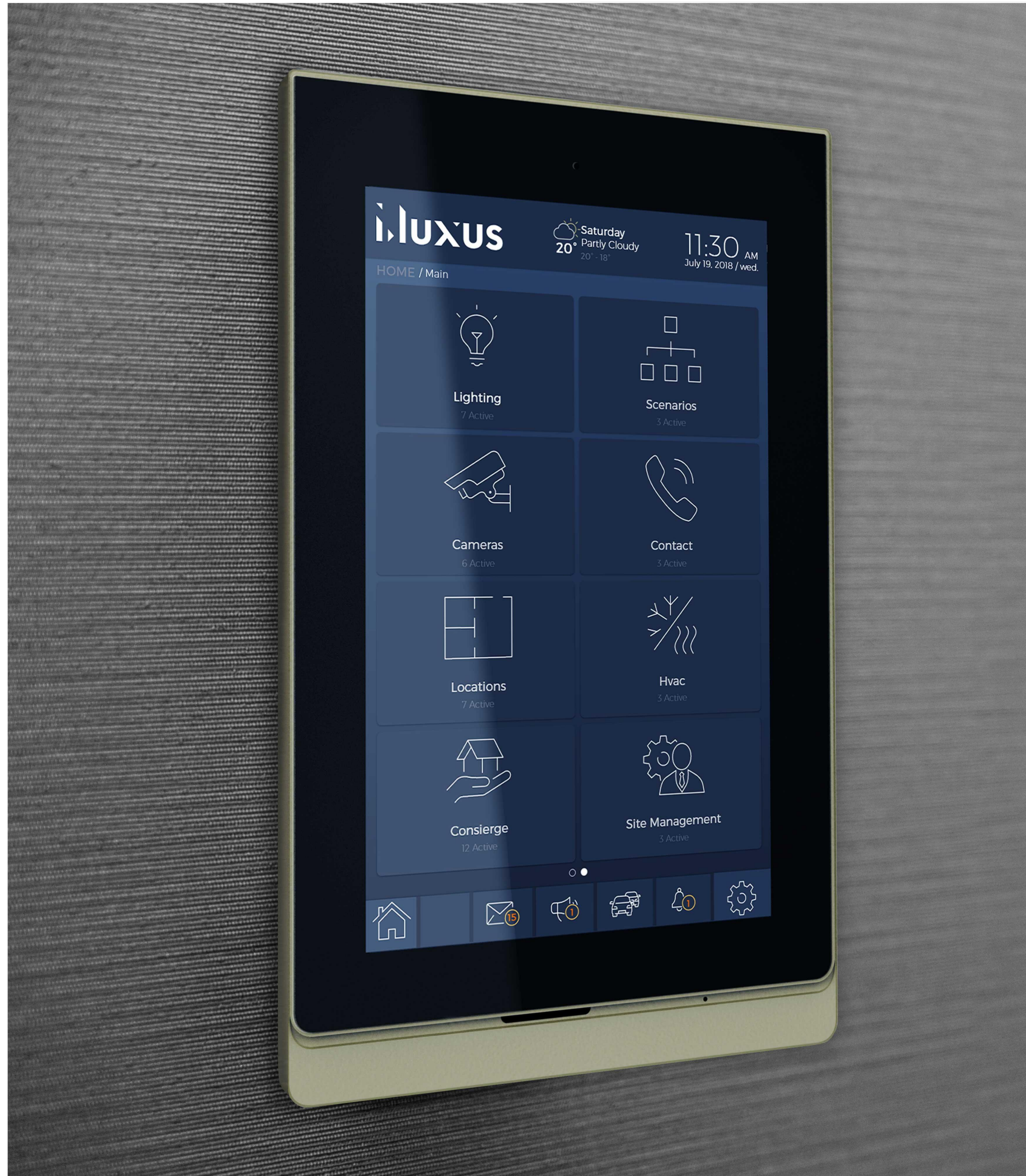

PRODUCT BENEFITS

EOZ TOUCH PANEL



IR Control
All kind of IR devices are in your control. Enjoy...



Lighting
Control every lighting object in KNX Bus System

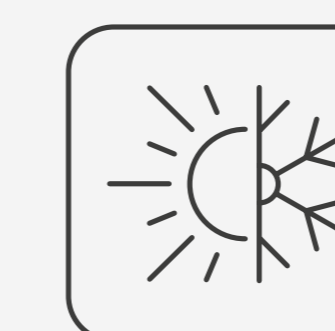

Air - Condition
All kind of air condition devices can control over EOZ



Intercom
Communicate with intercom & SIP based devices over IP System.



Cameras
Watch all cameras over IP System from EOZ&Mobile App.



Security
Stay in secure with every sensor devices which connected to EOZ



KNX MODULES

- Power Supply
- Switch Actuator
- 0 / 10V Analog IO
- AC KNX Gateway
- Push Button Interface



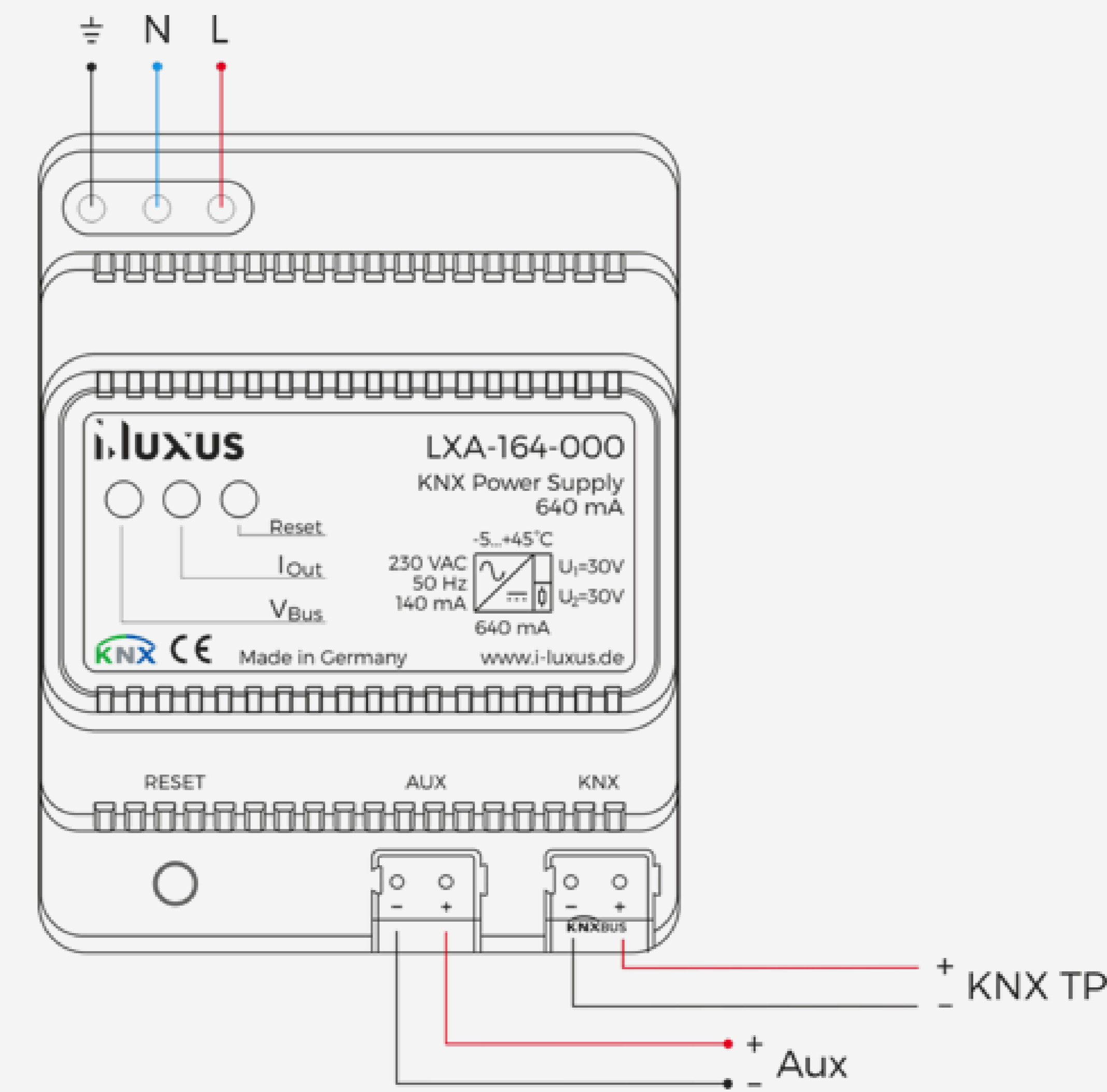

**KNX
MODULES**

POWER SUPPLY

- 640 mA Power Supply
- KNX Output Voltage
- Aux Output Voltage 30V
- 4 Module – 4x18 mm





SWITCH ACTUATOR

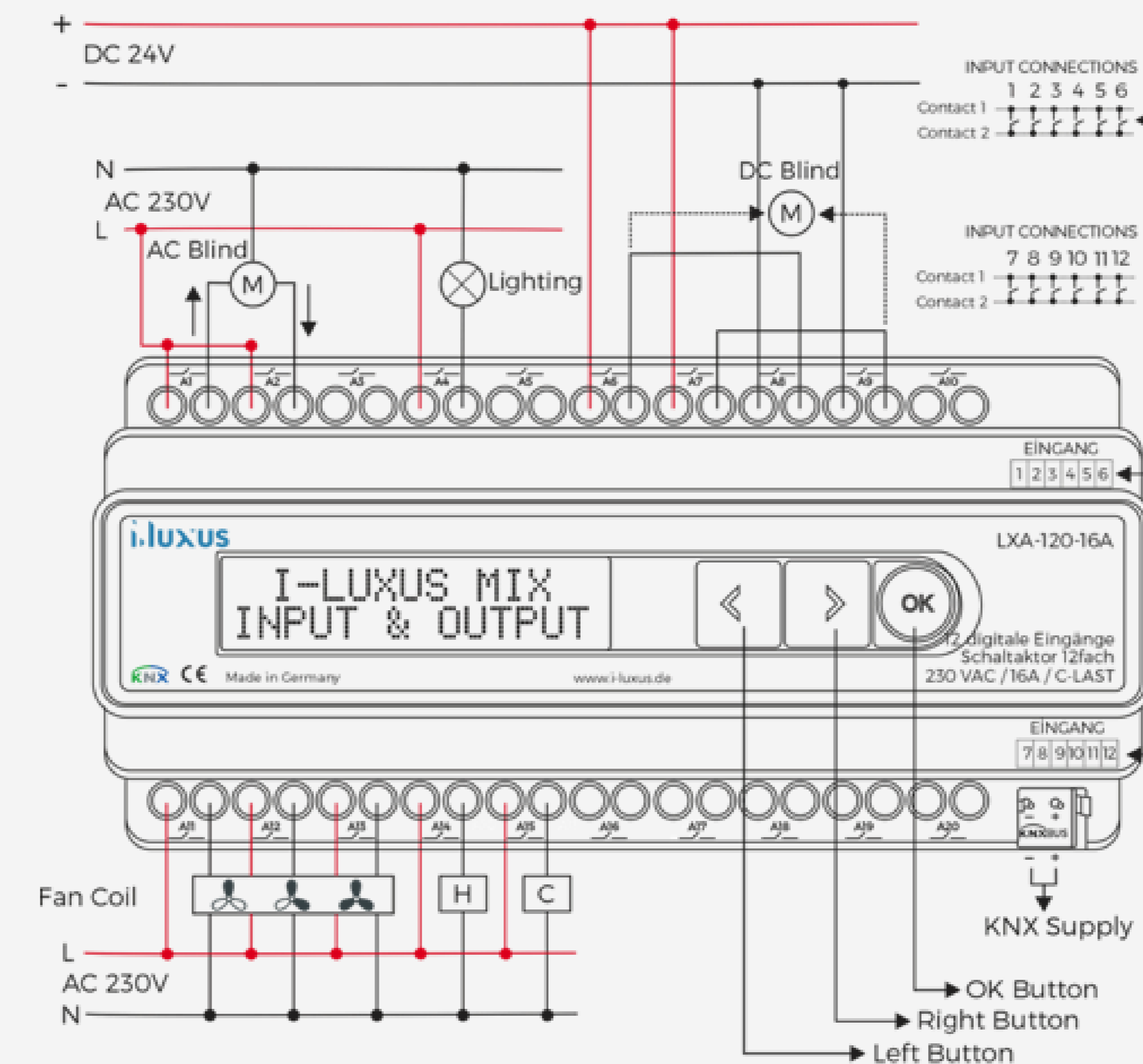

**KNX
MODULES**

- Lighting Function
- Shutter and Blind Function (230V and 24V)
- Fan coil functions for 2 & 4 pipe
- 12 or 20 Gang 16A Outputs – 102A Inrush – AC 230V
- 12 Binary Inputs – DC 5V Pulsed



SWITCH ACTUATOR

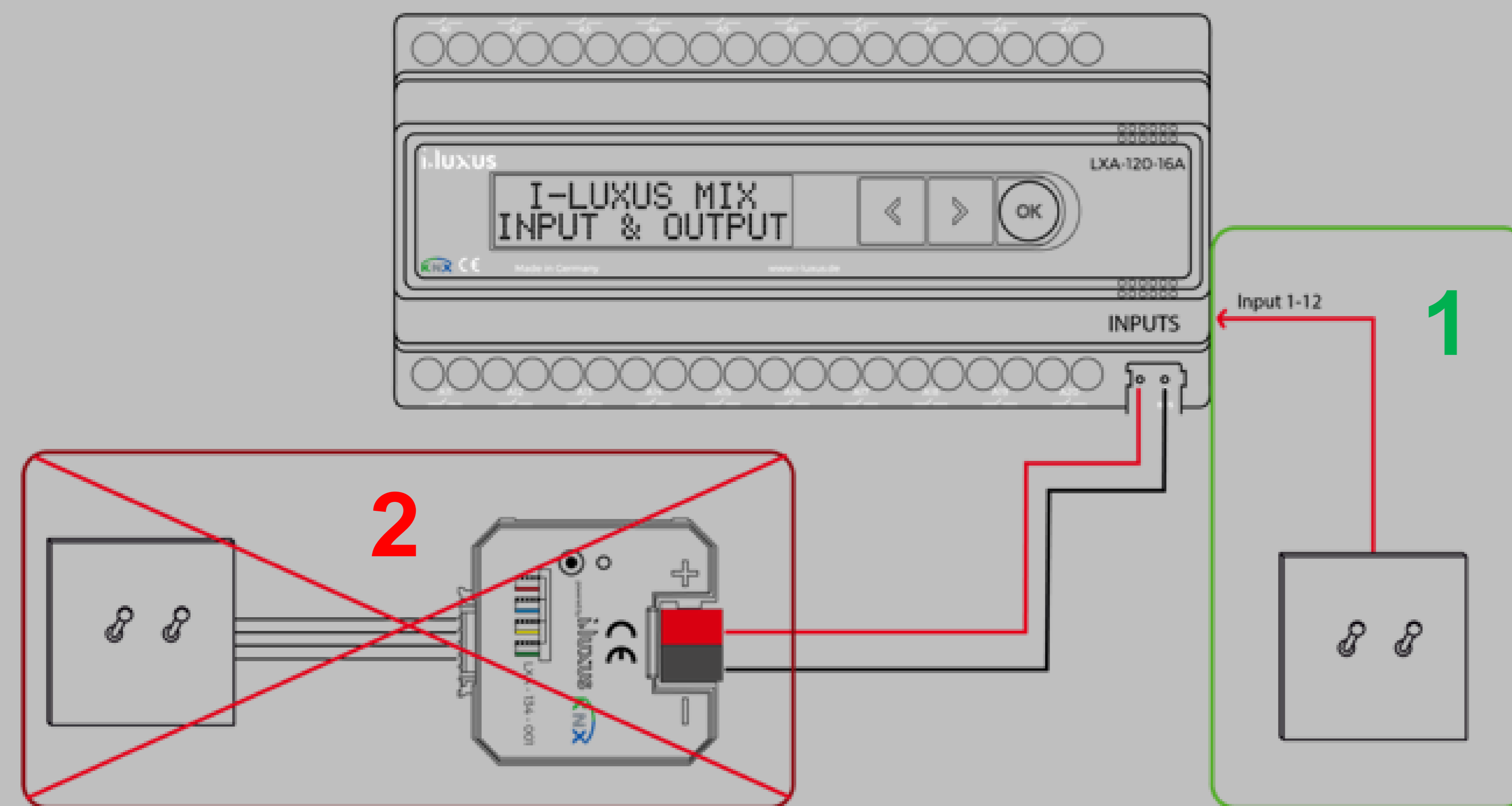

PRODUCT BENEFITS

- 1** Directly connected switch buttons to switch actuator's Input connector as a dry contact
- 2** Switch buttons needs KNX Gateway (like push button interface) to communicate with switch actuators

Roughly you need 3 pcs 4 gang Push Button Interface for 12 inputs

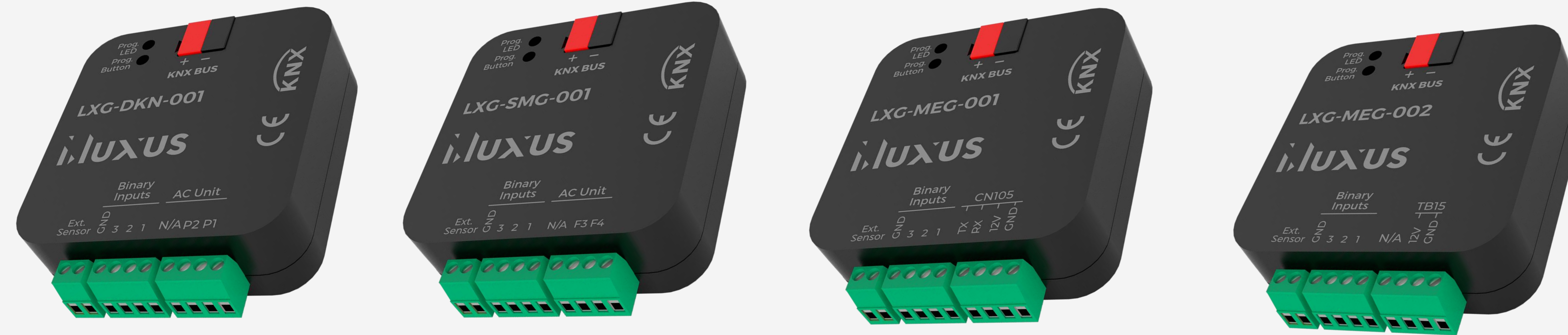

KNX MODULES

AC GATEWAY

- External temperature sensor input.
- 3 digital inputs that can be integrated into the KNX bus line.
- Possibility to control with 10 different scenarios
- Energy saver functions.



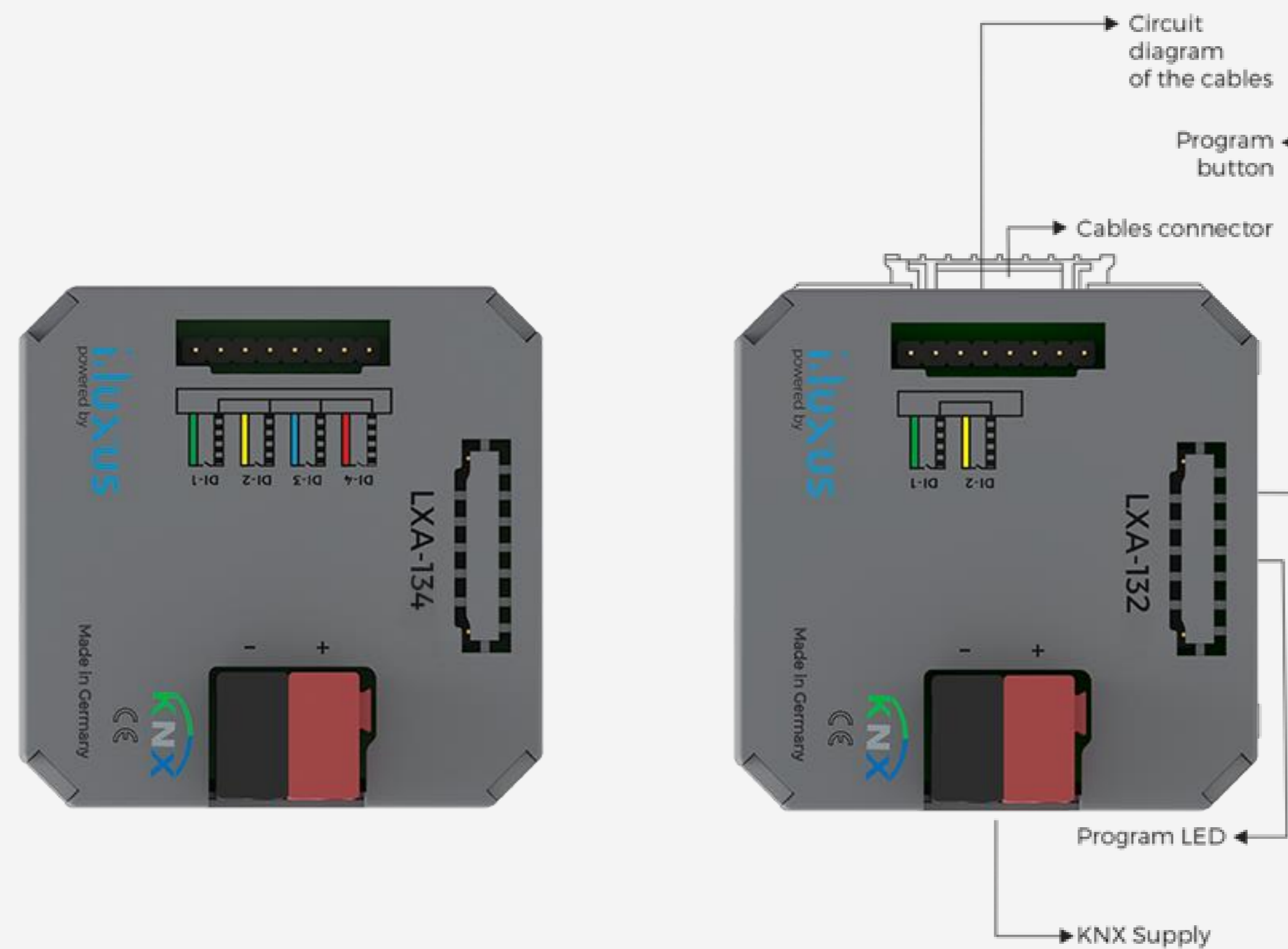

KNX MODULES

PUSHBUTTON INTERFACE

- 4 functional input channels
- Easy connection with colorful connection cables
- Possibility to incorporate dry contact data into the KNX line
- Switching, scene, counter, send value, shutter/blind and dimming operations
- Configurable with ETS



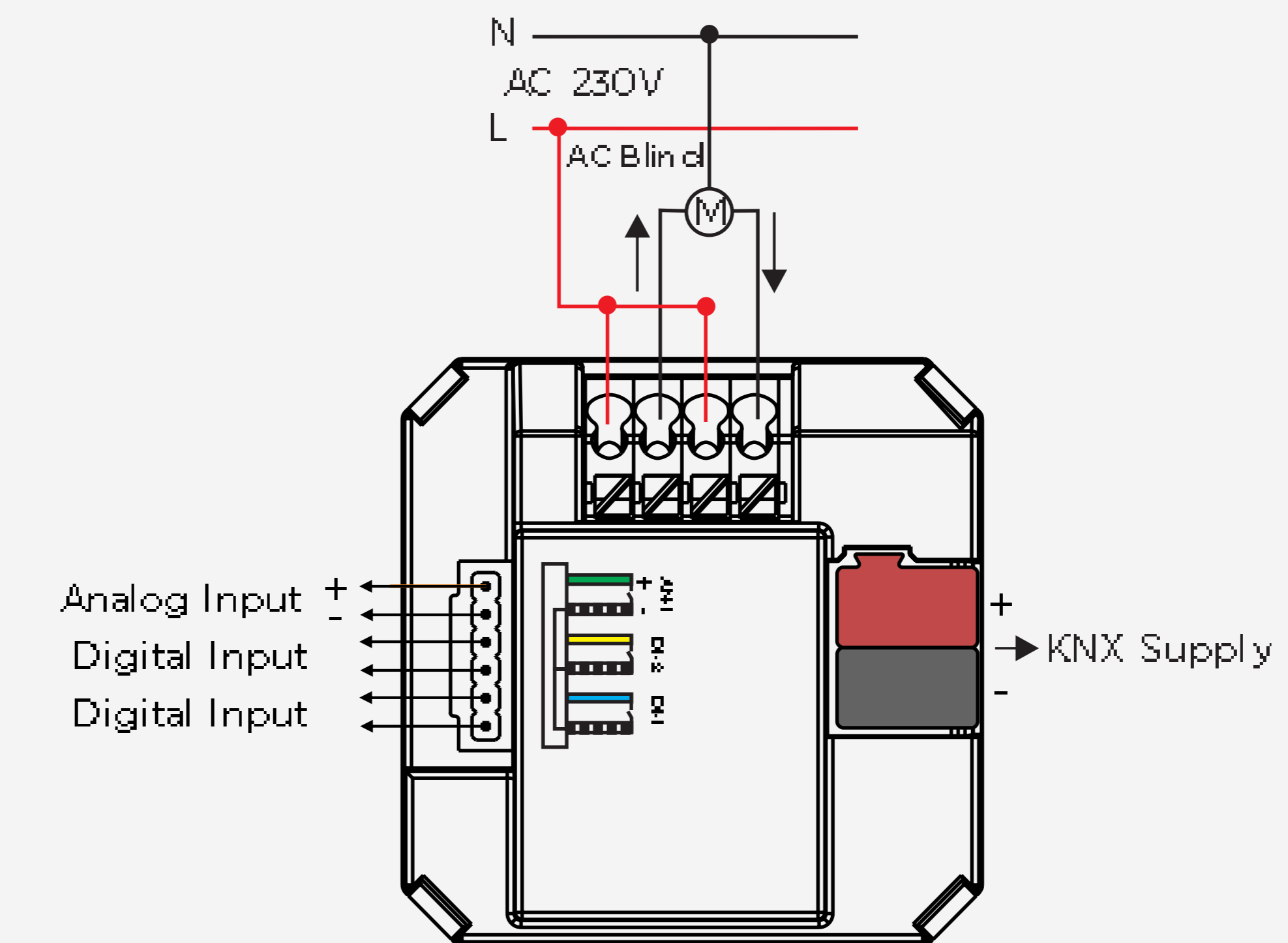
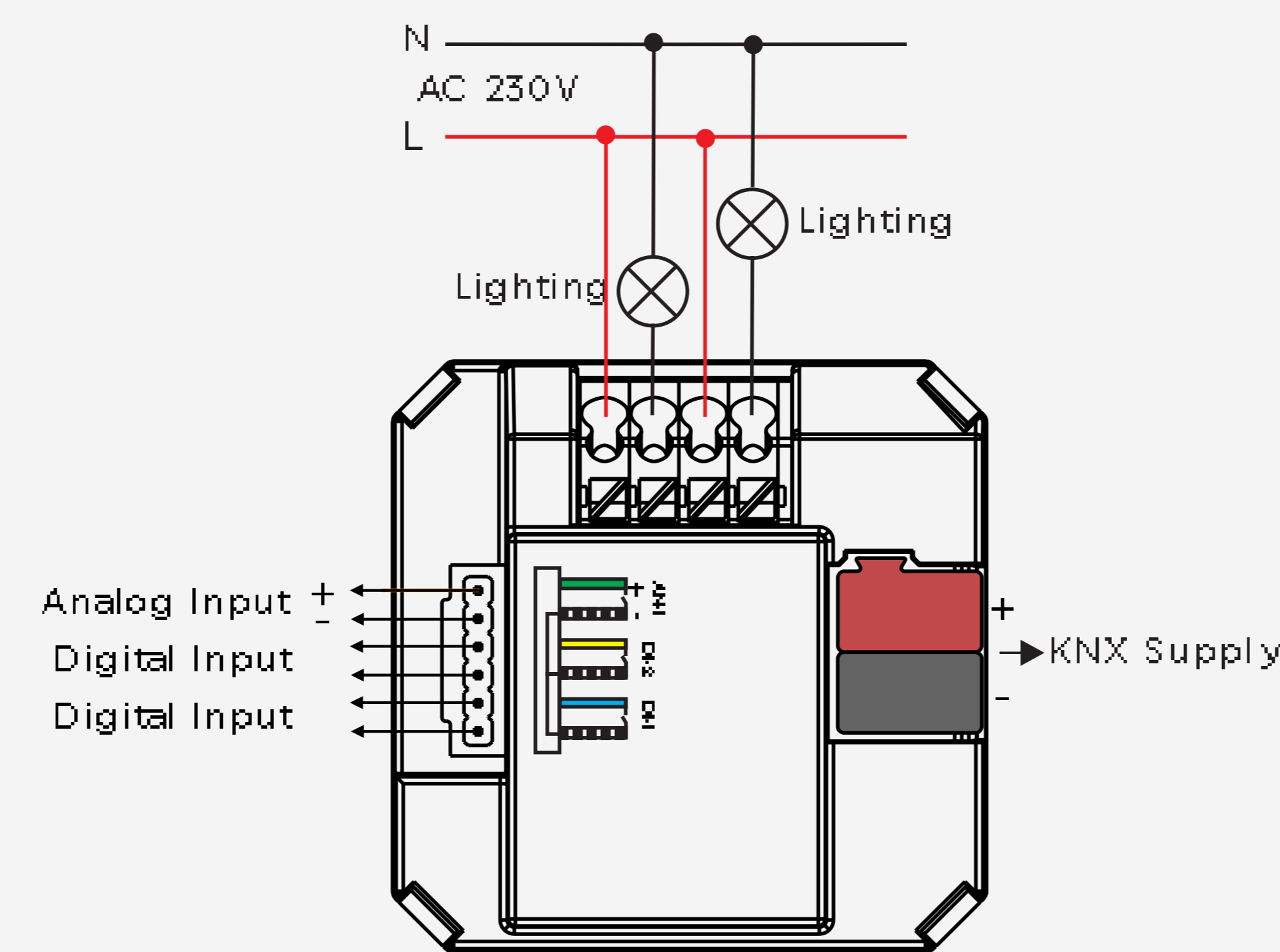
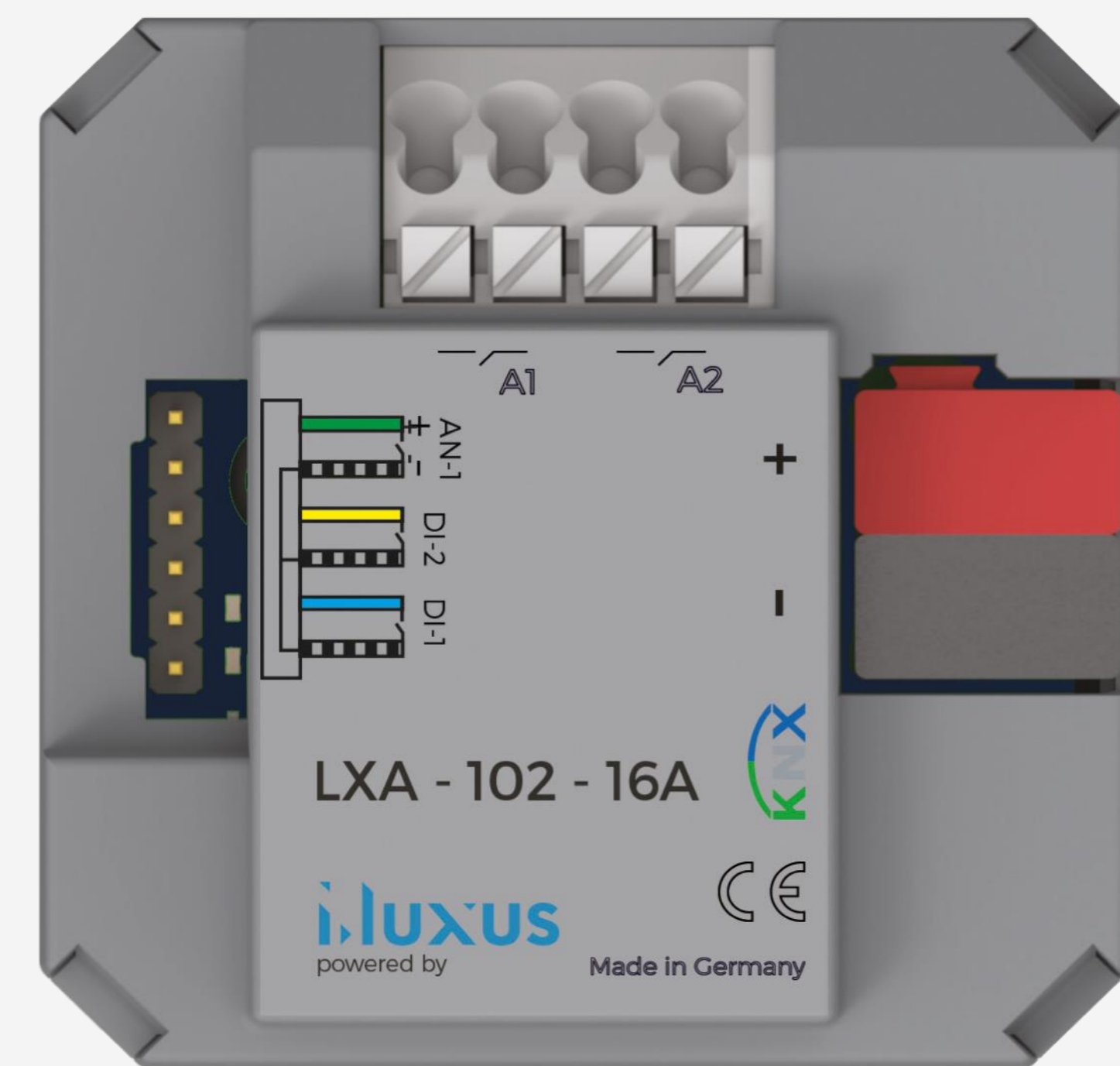

KNX MODULES

FLUSHMOUNT ACTUATOR

- 2 Relay outputs (16A, 230V AC)
- 2 Digital (Dry Contact) Inputs
- 1 Analog Input
- Lighting, Shutter&Blind Functions
- Heating, Logic, Timing Functions





MARKETING

As a brand, we offer support for our customers and business partners in order to provide the necessary materials for the events and presentation that should be done on behalf of marketing.



KEEP IN TOUCH

www.i-luxus.de

AUTHORIZED
GOLD
PARTNER
CERTIFICATE



We hereby Authorized:

Managing Director: Mr. Amr Zidan

Address: Delta Flowers Towers,
Makram Ebaid St, Nasr City,
Cairo Tower 2, Unit 501

Masterpiece Integrated Systems

As our Gold partner to promote, negotiate, sell, responsible for all the after-sales service on behalf of i-luxus GmbH in the whole territory of EGYPT for sale of our products.

- ▶ This Certification commences on the date of signing and is valid for one year.
- ▶ From 22.08.2022 to end date 22.08.2023.
- ▶ This Certification will become null and void unless it is agreed between both parties to mark an extension.

Yours faithfully.

Volkan Alçınkaya

A handwritten signature in blue ink, appearing to read 'Volkan Alçınkaya'.

GLD. 02-22082022

iLUXUS
INTELLIGENT LUXURY BUILDING SOLUTIONS

Biberweg 27, 53842 Troisdorf, Germany | Telephone: +49 2241 898 08 20



CERTIFICATE

*This is to certify that the
Quality Management System of*

Masterpiece Integrated Systems

Egypt Cairo, Nasser City, 4 Hafez Ramadan St 5th Floor

has been assessed and found to conform to the requirements of

ISO 9001:2015

This Certificate is valid for the following scope:

- **ELV systems supplier and distributor for both Private and Government Sector.**
- **Implementing, Supply and Install building automation and audiovisual solutions.**

Certificate No.	:BQSR22274
Registration Date	:04/03/2023
Issue Date	:06/03/2023
Expiry Date	:03/03/2024
Recertification Date	:03/03/2026



Director

BQSR QUALITY ASSURANCE PVT. LTD.

Key Location: 183 Broadway, Ste 210 Hicksville, New York NY 11801, USA
Operations Office: D 303, 104-108, Nisarg Plaza, Wakad, Pune - 411057. | Web: www.bqsrcert.com
Accredited by IAS (3060 Saturn Street, Suite 100, Brea, California 92821 U.S.A.)





CERTIFICATE

*This is to certify that the
Information Security Management System of*

Masterpiece Integrated Systems

Egypt Cairo, Nasser City, 4 Hafez Ramadan St 5th Floor

has been assessed and found to conform to the requirements of

ISO/ IEC 27001:2013 Information Security Management System

This Certificate is valid for the following scope:

- **ELV systems supplier and distributor for both Private and Government Sector.**
- **Implementing, Supply and Install building automation and audiovisual solutions.**

SOA, Version: 01; Dated:11/01/2023

Certificate No.	:BQSR22275
Registration Date	:04/03/2023
Issue Date	:06/03/2023
Expiry Date	:03/03/2024
Recertification Date	:03/03/2026



Director

BQSR QUALITY ASSURANCE PVT. LTD.

Key Location: 183 Broadway, Ste 210 Hicksville, New York NY 11801, USA
Operations Office: D 303, 104-108, Nisarg Plaza, Wakad, Pune - 411057. | Web: www.bqsrcert.com
Accredited by IAS (3060 Saturn Street, Suite 100, Brea, California 92821 U.S.A.)



Advanced

Azure F100 V.3 Kit
+ In-ceiling SP. 7.1 Ch (5.1.2)

Marantz SR5015
/ Dolby Atmos / DTS:X

SW 10
(10" Active Subwoofer)



TAGA

HARMONY

Best Value

TAGA F-607 Kit 5.0

Denon AVR - X550 BT 5.1 Ch
/Dolby true HD /DTS HD

TSW 210
(10" Active Subwoofer)



Basic

TAGA F-506 Kit 5.0

Denon AVR - X550 BT 5.1 Ch
/Dolby true HD /DTS HD

TSW 210
(10" Active Subwoofer)



TAGA name comes from the first letters of the company tagline: **To Achieve Glorious Acoustics**

 Masterpiece A/V Solutions
 www.masterpieceavs.com

Available at our Showroom: **Fifth Settlement**
Contact Us: **01558998833 / 01000300432**

masterpiece
Audio, Video & Solutions

Platinum Series

Born in **Europe** – Crafted for the World

F-120 v.3 | Front Speakers

Design:
Floor standing ,3-Ways ,5 drivers
1 x tweeter
1x mid-range driver
3 x woofer

Power Handling:
210W RMS @ 4 Ohms, 93dB

F.R.:
28Hz - 40kHz

Dimensions (HxWxD), weight:
118 x 25 x 34 cm, 23.3 kg / pc.



B-40 V.3 | Rear Speakers

Design:
Book shelf ,2-Ways
1 x tweeter
1x mid-woofer driver

Power Handling:
105W RMS @ 6 Ohms, 88 dB

F.R.:
40Hz - 40kHz

Dimensions (HxWxD), weight:
36 x 21 x 25.3 cm, 6.9 kg / pc



C-100 | Center Speakers

Design:
Book shelf ,2-Ways ,6 drivers
1 x tweeter
5 x mid-range driver

Power Handling:
150W RMS @ 6 Ohms, 90 dB

F.R.:
38Hz - 40kHz

Dimensions (HxWxD), weight:
16.5 x 89 x 10 cm, 8 kg / pc.



Azur Series

The taste of **Côte d'Azur* redefined!**
*(French Riviera Coast)

F-100 v.2 | Front Speakers

Design:
Floor standing ,3-Ways ,4 drivers
1 x tweeter
3 x mid-woofer

Power Handling:
150W RMS@ 6 Ohms, 89 dB

F.R.:
36Hz - 40kHz

Dimensions (HxWxD), weight:
100.5 x 21 x 27 cm, 20.8 kg / pc.



B-40 V.3 | Rear Speakers

Design:
Book shelf ,2-Ways, 2 drivers
1 x tweeter
1x mid-woofer driver

Power Handling:
110W RMS @ 6 Ohms, 89 dB

F.R.:
38Hz - 40kHz

Dimensions (HxWxD), weight:
41 x 25 x 27.2 cm, 7.8 kg / pc



C-40 V.2 | Center Speakers

Design:
Book shelf, 2-Ways, 3 drivers
1 x tweeter
2 x mid-range driver

Power Handling:
90W RMS @ 6 Ohms, 90 dB

F.R.:
42Hz - 40kHz

Dimensions (HxWxD), weight:
17 x 50 x 20.9 cm, 5.9 kg / pc.



TAV series 607

Hallmark of the **Audio-Video series!**

TAV-607S
Rear Speakers

Design:
Book shelf, 2-Ways, 2 drivers
1 x tweeter
1x mid-woofer driver

Power Handling:
50W RMS @ 6 Ohms, 87 dB

F.R.:
55Hz - 25kHz

Dimensions (HxWxD), weight:
26.5 x 16.5 x 14.5 cm, 2.5 kg / pc.

TAV-607F
Front Speakers

Design:
Floor standing, 3-Ways, 4 drivers
1 x tweeter
1 x mid-range
2 x woofer

Power Handling:
90W RMS@ 6 Ohms, 91 dB

F.R.:
40Hz - 25kHz

Dimensions (HxWxD), weight:
98 x 21 x 29 cm, 14 kg / pc.

TAV-607C
Center Speakers

Design:
Book shelf, 2-Ways, 3 drivers
1 x tweeter
2 x mid-range driver

Power Handling:
50W RMS @ 6 Ohms, 88 dB

F.R.:
55Hz - 25kHz

Dimensions (HxWxD), weight:
16.5 x 43 x 14.5 cm, 3.8 kg / pc.

Thunder Subwoofer Series

240 Watts of **affordable great bass!**

TSW-210 | Subwoofer



Perfect match with: **TAV-806 / TAV-607 / TAV-506

Design:
Active subwoofer, 1 x 12" driver

Power Handling:
240W RMS, 750W Dynamic Peak

F.R.:
23Hz - 200Hz

Dimensions (HxWxD), weight:
40.2 x 37 x 44.8 cm, 21 kg / pc

TAV series 506

Combine **high quality sound and dynamic resolution**

TAV-506S
Rear Speakers

Design:
Book shelf, 2-Ways, 2 drivers
1 x tweeter
1x mid-woofer driver

Power Handling:
50W RMS @ 6 Ohms, 87 dB

F.R.:
55Hz - 25kHz

Dimensions (HxWxD), weight:
26.5 x 16.5 x 14.5 cm, 2.5 kg / pc.

TAV-506C
Center Speakers

Design:
Book shelf, 2-Ways, 3 drivers
1 x tweeter
2 x mid-range driver

Power Handling:
50W RMS @ 6 Ohms, 88 dB

F.R.:
55Hz - 25kHz

Dimensions (HxWxD), weight:
16.5 x 43 x 14.5 cm, 3.8 kg / pc.

TAV-506F
Front Speakers

Design:
Floor standing, 3-Ways, 4 drivers
1 x tweeter
3 x mid-range
2 x woofer

Power Handling:
90W RMS@ 6 Ohms, 89 dB

F.R.:
42Hz - 25kHz

Dimensions (HxWxD), weight:
90 x 17 x 23.5 cm, 10.2 kg / pc.

Platinum Subwoofer Series

High performance has never been available in this price level

SW-10 | Subwoofer



Perfect match with: **Platinum Series / Azure Series

Design:
Active subwoofer, 1 x 10" driver

Power Handling:
240W RMS, 750W Dynamic Peak

F.R.:
20Hz - 200Hz

Dimensions (HxWxD), weight:
43 x 35 x 41 cm, 23.6 kg / pc

Innovation, Value, Quality and competitive cost .. everything you want in an audio product There's no reason to settle for anything less.

20 – years in market , Dayton audio mission is to calibrate a fine balance between technology and art in order to exceed our customers' expectations

**DON'T
SETTLE
FOR LESS**

DAX66

6-Source 6-Zone Distributed Audio System



Product Highlights

- **6-source** inputs, **6-zone** outputs; expandable to **18 zones**
- **Class D** amplifier **12-ch x 25 W RMS**, (Bridgeable **100 W RMS**) per zone at 8 Ohms.
- **System control by IR remote, keypad, automation** system by RS232 interface
- Pre-amp outputs provide the option to **connect more-powerful amplifiers** or even expand a zone

Music Streamer | WBA28

Wi-Fi Bluetooth Multi-Room Wi-Fi Streamer

- Convert any current audio system into an **affordable, wireless, app-controlled** set-up using Hi-Fly app
- Add up to 6 devices to have a **6-zone** distributed home audio system.
- Play your favorite music via **Airplay, DLNA, Bluetooth**
- Stereo 3.5 mm in/out, Digital optical, Ethernet port
- **USB port** for music files



Pendant Speaker | WB65Bt

- Versatile mounting brackets for **pendant mounting, wallmount, or spear** landscape applications.
- **2-way Speaker**, 6.5" / 4.5" woofer with a coaxial 1" tweeter providing a balanced, natural response.
- Integrated **70V/100V transformer, 8-ohm bypass**.
- Suitable for **Outdoor (IP66) weather resistant**

Amplifier | WB40A

Wi-Fi Bluetooth Multi-Room 2x20W Amplifier

- Highly efficient **2x20 watt**, directly connect your speakers.
- Group multiple amplifiers using **Hi-Fly App** together to create a wireless multi-room sound system
- Play your favorite music via **Airplay, DLNA, Bluetooth**
- Stereo **3.5 mm in, USB port** for music files



Ceiling Speaker | CS620CT/CS820CT

- Add music to **kitchen, den, bath, or patio!**
- **Weather resistant**, ideal for **restaurants, offices, or industrial areas**.
- **2-way Speaker** 6-1/2" / 8" woofer 1" dome tweeter
- **70V transformer** tapped at **0.62W, 1.25W, 2.5W, 5W and 10W**



EXPECT GREAT SOUND



magnifi mini™

Home Theater Sound Bar System™

 Masterpiece A/V Solutions
 www.MasterpieceAVS.com

Available at our Showroom: **Fifth Settlement**
Contact Us: **01558998833 / 01000300432**



magnifi mini™

PRODUCT INFORMATION SHEET



Big Polk Sound From an Ultra-Compact Bar

The MagniFi Mini delivers the big, room-filling home theater experience you'd expect from a full-size sound bar in an ultra-compact design. Compatible with most TVs, it's easy to set up and features Polk's VoiceAdjust™ and surround sound technologies, ensuring crystal clear dialogue and immersive surround sound—plus an included wireless subwoofer for deep bass impact you can feel. Stream your favorite music through Bluetooth® and GoogleCast.

Elevated Surround Sound

Polk's patented surround technology and 5.1 Dolby® Digital decoding create incredible room-filling surround sound from the ultra-compact six driver sound bar and wireless subwoofer.

Crystal Clear Dialogue with Polk VoiceAdjust Technology

Customize the voice levels in the sound bar however you prefer to reproduce clear, crisp dialogue and never miss a single word of your favorite movie, TV show or sporting event.

Optimized Movie, Music, and Sport EQ Settings

One button preset EQ settings for Movies, Music and Sports (great for news and talks shows, too) optimize the sound bar and subwoofer to ensure you get the clearest dialogue, big surround sound and deep bass for the best audio and home theater experience.

Exclusive Full Complement Deep Bass Technology

The MagniFi Mini sound bar and included wireless subwoofer reproduce deep bass impact you can feel, creating a room-filling and immersive home theater and music listening experience.



Universal Compatibility

Works with any TV, cable box or satellite IR remote control—there's no need for two remotes.

Easy Setup

Get up and running in minutes, the included HDMI cable lets you plug directly into the sound bar from the TV—power-up and you're ready to go.

Wireless Music Streaming

Includes WiFi, Google Cast and Bluetooth—stream music directly from your smartphone, tablet or other compatible device.

Ultra-Compact Size

Fits tight spaces and still delivers big, room-filling audio. Don't let the size fool you—this is that big Polk sound you love from a little bar.

Night Effect

Don't wake your family or neighbors and stop straining to hear the evening news. With Night Mode, one button lowers the bass and increases VoiceAdjust delivering clear dialogue all without raising the master volume.

Take Control of Everything You Hear

In addition to master volume, the remote control includes separate bass and VoiceAdjust volume settings.

Expect Great Sound

Having built our reputation as "The Speaker Specialists" for more than 40 years, we take pride in our superior sound and build quality, which features many patented and award-winning audio innovations like Dynamic Balance and VoiceAdjust technologies. For the people of Polk, building audio products is not just a job—it's a passion. And if you're going to remember one thing, remember this: We live by the truest principle of what audio should deliver—great sound at an affordable price for everyone!

SPECIFICATIONS

Bar	2 x .5" (12mm) tweeters 4 x 2.25" (57mm) drivers Measures 3.11 H x 13.4" W x 4.25" D (79mm H x 341mm W x 108mm D)
Subwoofer	6.5" (165mm) Measures 14.5 H x 7.4" W x 14.4" D (368mm H x 188mm W x 366mm D)
Total Frequency Response	40Hz-24kHz
Total System Power	150W
Inputs	HDMI ARC, Optical, 3.5mm (analog)
WiFi	Yes, Google Cast
Bluetooth	Yes
EQ Modes	Movie, Music, Sport and Night
Volume Controls	Master, Bass, VoiceAdjust
In the Box	2M HDMI cable, 1.8M Optical Cable, IR Remote with 2 AAA batteries, power cables for bar and sub, QSG

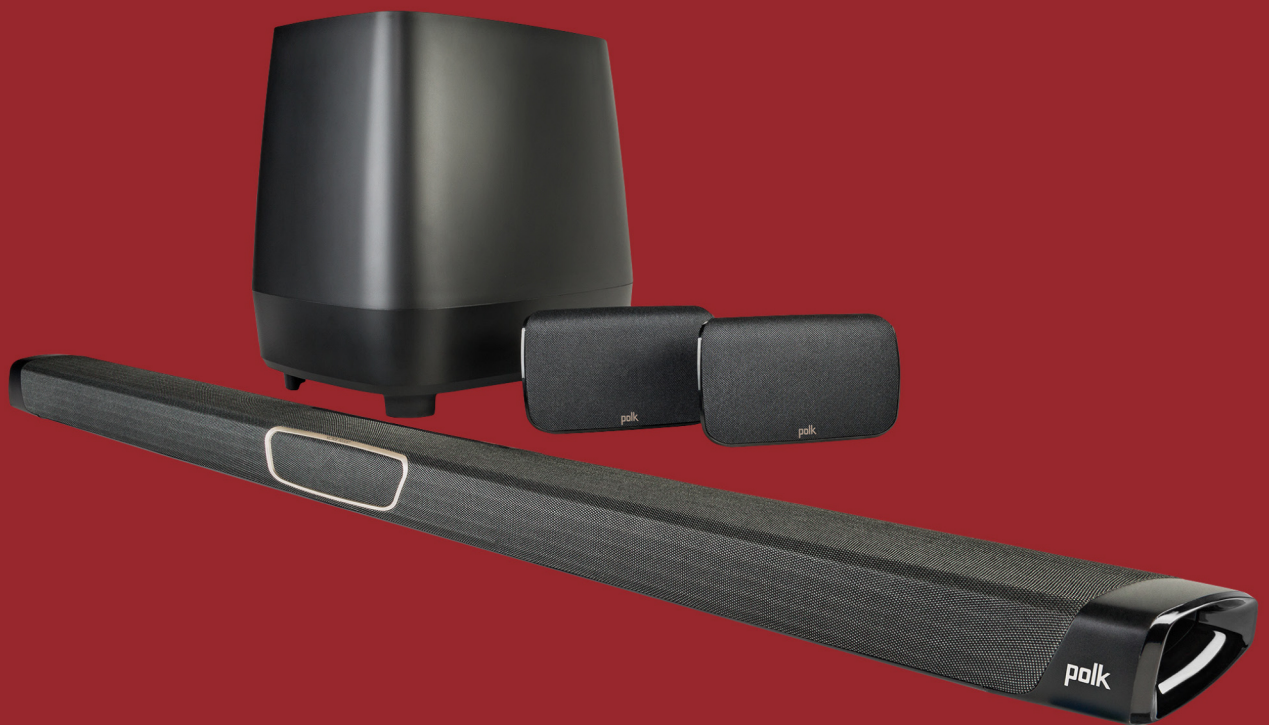

magnifi MAXSR™

Maximum-Performance True 5.1
Home Theater Sound Bar System



Specifications	
Drivers	(4) 1" x 3" (25 x 75mm) full-range drivers, (2) 0.75" (19mm) tweeters and (1) 1" (25mm) center channel driver 8" (200mm) ported, wireless subwoofer (1) 3" round driver in each SR1 wireless rear speaker
Inputs	(3) built-in 4K HDMI inputs (HDCP 2.2 compliant), (1) HDMI (ARC) output, optical input for TV audio, AUX 3.5mm, Bluetooth, Google Home featuring Chromecast for audio, Ethernet (RJ45) for music streaming
Frequency Response	35Hz - 20kHz
Included in Box	MagniFi MAX sound bar Wireless Subwoofer (2) Polk SR1 wireless rear speakers Deluxe remote control (2) AAA batteries Sound bar power adapter with power cord Subwoofer power cord 6.5' (2m) high-speed HDMI cable 6' (1.8m) Optical cable 6' (1.8m) 3.5mm AUX cable (2) wall-mounting brackets (screws and fasteners not included) Sound bar wall-mount template Literature
Wall Mountable	Yes
SKU #	AM8414 INTL: AM8415
UPC	747192128241 INTL: 747192128258
Warranty	1 Year Amplifiers / 3 Years Speakers
Dimensions	Bar: 43"W x 2.09"H x 3.78"D 1092.4mm W x 53.1mm H x 96mm D Sub: 12.11"W x 14.53"H x 14.62"D 307.6mm W x 369.2mm H x 371.4mm D

The Polk MagniFi MAX SR maximum-performance true 5.1 home theater sound bar system provides bigger, more dynamic surround sound than traditional sound bars—and is optimized to make movies, TV, sports and music come alive. It features patented SDA surround technology for a wider, more immersive listening experience and Polk VoiceAdjust technology for crystal clear dialogue—and it's equipped with Polk Smart Remote technology, so it works with your TV's remote control right out of the box. Includes a wireless subwoofer and two Polk SR1 wireless rear speakers for true surround sound—plus, HDMI (4k compatible) and optical cables for quick and easy setup. And, Google Chromecast Built-in and Bluetooth technologies let you stream all of your favorite music. Compatible with most major TV manufacturers.

Features

Patented Polk SDA Surround Technology

Creates an expansive soundstage and detailed stereo image, while delivering a natural multi-dimensional sound experience you would expect from a concert or theater by eliminating cross-talk found in all other sound bars and TV speakers.

Polk VoiceAdjust Technology

Customize the voice levels in the sound bar however you prefer to reproduce clear, crisp dialogue and never miss a single word of your favorite movie, TV show or sporting event.

Google Chromecast Built-in

Stream music from your favorite apps over Wi-Fi, connect to your Google Home speaker and control your music with voice commands via Google Assistant.

True 5.1 Wireless Surround Sound

Seven driver array, the included powerful wireless subwoofer and two Polk SR1 wireless rear speakers create an immersive multi-dimensional sound via 5.1 Dolby Digital, DTS and exclusive Polk SDA surround technology for an incredible room-filling listening experience.

Built-in Remote Control Compatibility

Control volume and mute with most Samsung, LG, Vizio, and Sony TV remotes (works with both optical HDMI connection), as well as most CEC enabled TVs - no programming or learning required.

Low-Profile

Slim design won't block your TV's remote sensor.

Exclusive Full Complement Deep Bass Technology

Included 8" ported wireless subwoofer give you a massive boost of core-pounding deep bass impact that takes home theater and music listening to a whole new level.

Movie, Music and Sport Modes

One button preset EQ settings for Movies, Music and Sports optimize the sound bar and subwoofer to ensure you get the clearest dialogue, big surround sound and deep bass for the best audio and home theater experience.

Night Mode

Lowers the bass and increases VoiceAdjust delivering clear dialogue all without raising the master volume.